

## DETAILS

<b>Product Number</b>	C11624_GT3-WW
<b>Family</b>	Gt3
<b>Type</b>	Lens array
<b>Color</b>	clear
<b>Diameter</b>	35 mm
<b>Height</b>	9 mm
<b>Style</b>	round
<b>Optic Material</b>	PMMA
<b>Holder Material</b>	
<b>Fastening</b>	pin, glue
<b>Status</b>	production ready
<b>ROHS Compliant</b>	Yes
<b>Date Updated</b>	10/11/2014



## OPTICAL PROPERTIES

LED	Viewing	Light	Effi-	cd/lm	Connector
	Angle	Beam	ciency		
XP-E	61 deg	Very Wide	90 %	0.760	-
XP-G	59 deg	Very Wide	90 %	0.860	-
XB-D	38 deg	Very Wide	92 %	1.400	-
LUXEON Rebel	46 deg	Very Wide	89 %	-	-
LUXEON Rebel ES	42 deg	Very Wide	92 %	-	-
LUXEON A	42 deg	Very Wide	-	-	-
NCSxx19A	sim: 50	Very Wide	sim: 92 %	-	-
NVSxx19A	sim: 50	Very Wide	sim: 92 %	-	-
Oslon SSL 80	54 deg	Very Wide	91 %	0.940	-
Oslon SSL 150	48 deg	Very Wide	87 %	1.100	-
Oslon Square EC	35 deg	Very Wide	91 %	1.470	-

### Relative intensity of C11624-GT3-WW-XBD

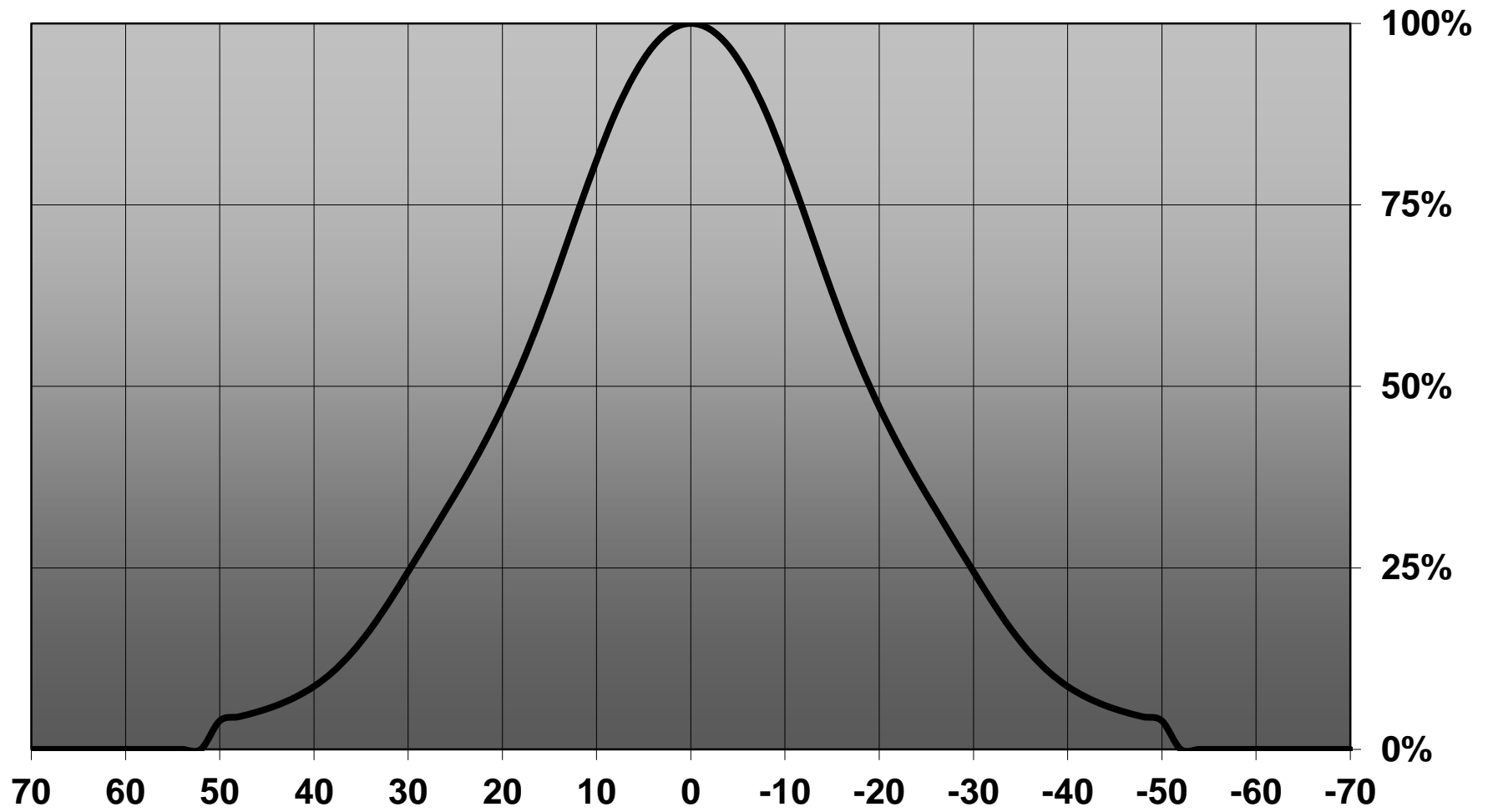

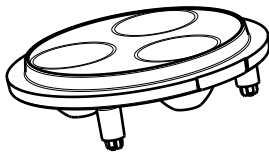

Isometric view  
Scale: 1:1

Material: PMMA

Part no.s:

- C10891\_GT3-XP-S
- C10891\_GT3-XP-G-S
- C10891\_GT3-OSL-S
- C10891\_GT3-DD-S
- C10891\_GT3-RE-ES-M
- C10891\_GT3-Z5-S
- C10892\_GT3-XP-M
- C10892\_GT3-XP-G-M
- C10892\_GT3-OSL-M
- C10892\_GT3-DD-M
- C10892\_GT3-XP-M
- C10892\_GT3-Z5-M
- C10893\_GT3-XP-W
- C10893\_GT3-XP-G-W
- C10893\_GT3-OSL-W
- C10893\_GT3-DD-W
- C10893\_GT3-RE-ES-W
- C11623\_GT3-RE-VW
- C11623\_GT3-N19-VW
- C11624\_GT3-XP-VW
- C11624\_GT3-XP-G-VW
- C11624\_GT3-OSL-VW
- C11624\_GT3-DD-VW
- C11624\_GT3-Z5-VW

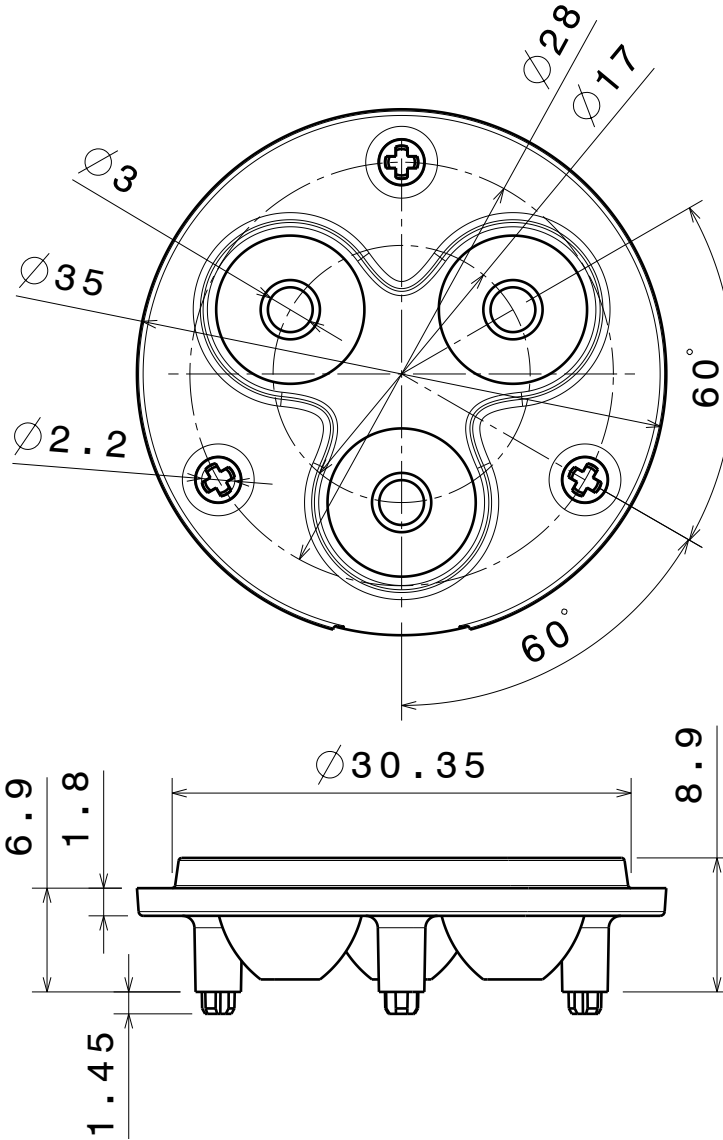

Bottom view

Front view

This drawing is our property.  
It can't be reproduced  
or communicated without  
our written agreement.



L  
T  
F  
F

e  
e  
i  
i  
N  
n

DRAWING TITLE

Datasheet GT3-Series Lens

DRAWN BY p		DATE 08.01.2010		DRAWING TITLE Datasheet GT3-Series Lens			
CHECKED BY t k		DATE 07.01.2010		SIZE A4	DRAWING NUMBER -	REV 1	
DESIGNED BY hh		DATE 07.01.2010		SCALE 2:1	WEIGHT (g)	SHEET 1/1	

# Ledil Oy C11624\_GT3-XP-WW C11624\_GT3-XP-WW / LDC (Linear)

Luminaire: Ledil Oy C11624\_GT3-XP-WW C11624\_GT3-XP-WW  
Lamps: 1 x Cree XP-E x3 white

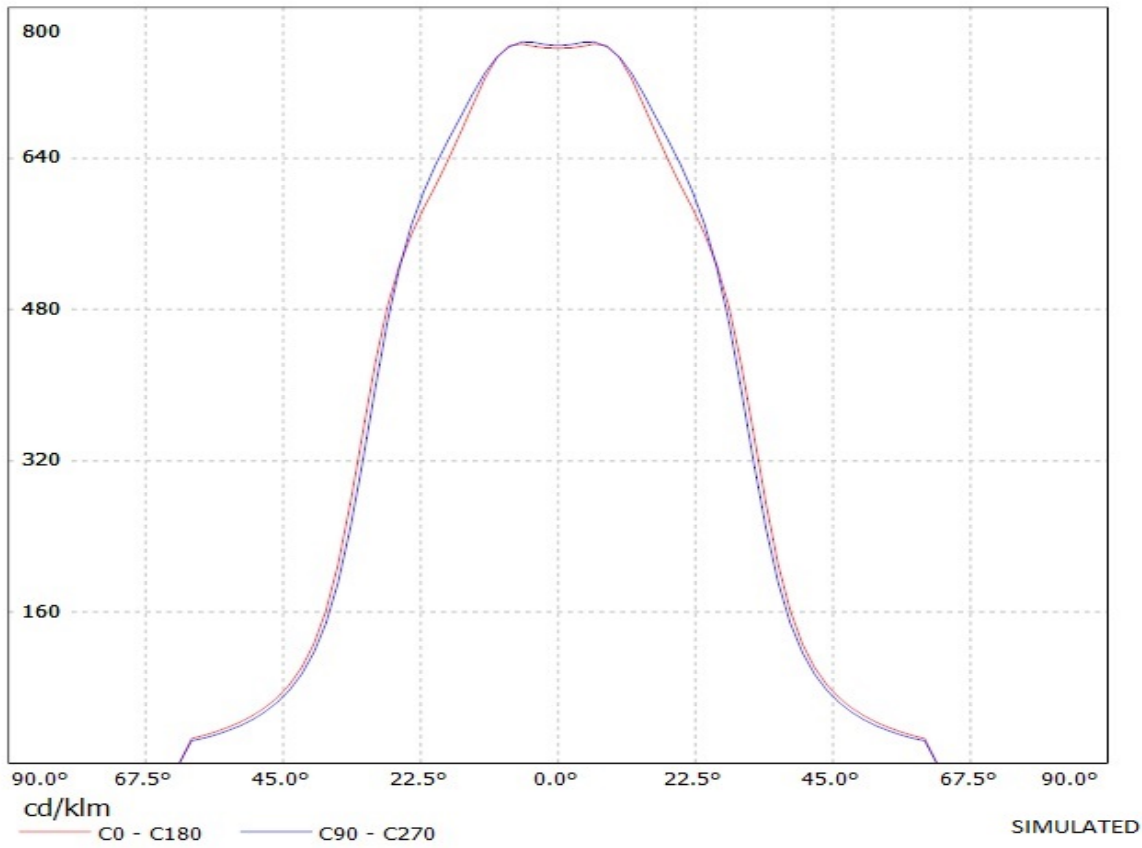

**Ledil Oy C11624\_GT3-XP-G-WW C11624\_GT3-XP-G-WW / LDC (Linear)**

Luminaire: Ledil Oy C11624\_GT3-XP-G-WW C11624\_GT3-XP-G-WW  
Lamps: 1 x Cree XP-G x3 white

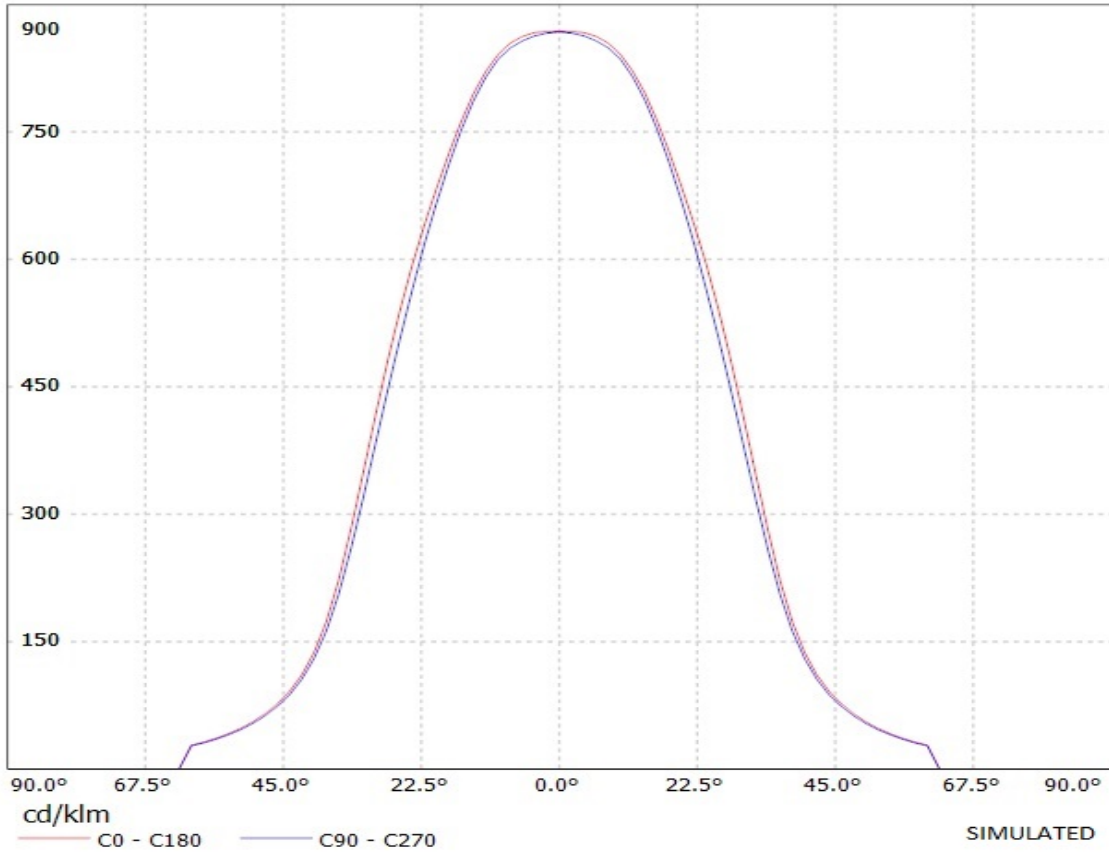

# Ledil Oy C11624-GT3-RE-ES-WW C11624-GT3-RE-ES-WW / LDC (Linear)

Luminaire: Ledil Oy C11624-GT3-RE-ES-WW C11624-GT3-RE-ES-WW

Lamps: 1 x Luxeon-Rebel-ES x3

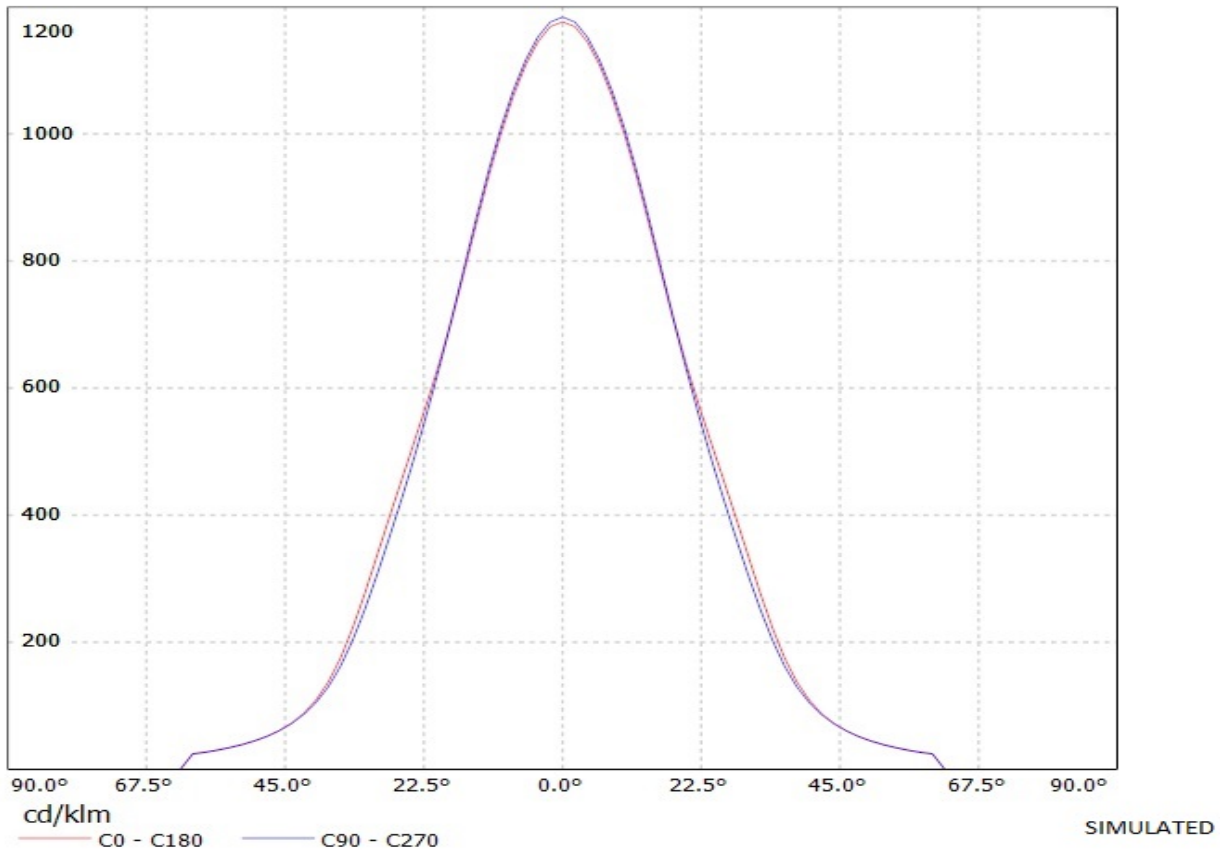

# Ledil Oy C11624\_GT3-OSL-WW C11624\_GT3-OSL-WW / LDC (Linear)

Luminaire: Ledil Oy C11624\_GT3-OSL-WW C11624\_GT3-OSL-WW  
Lamps: 1 x Osram OSL 80 deg x3 whit

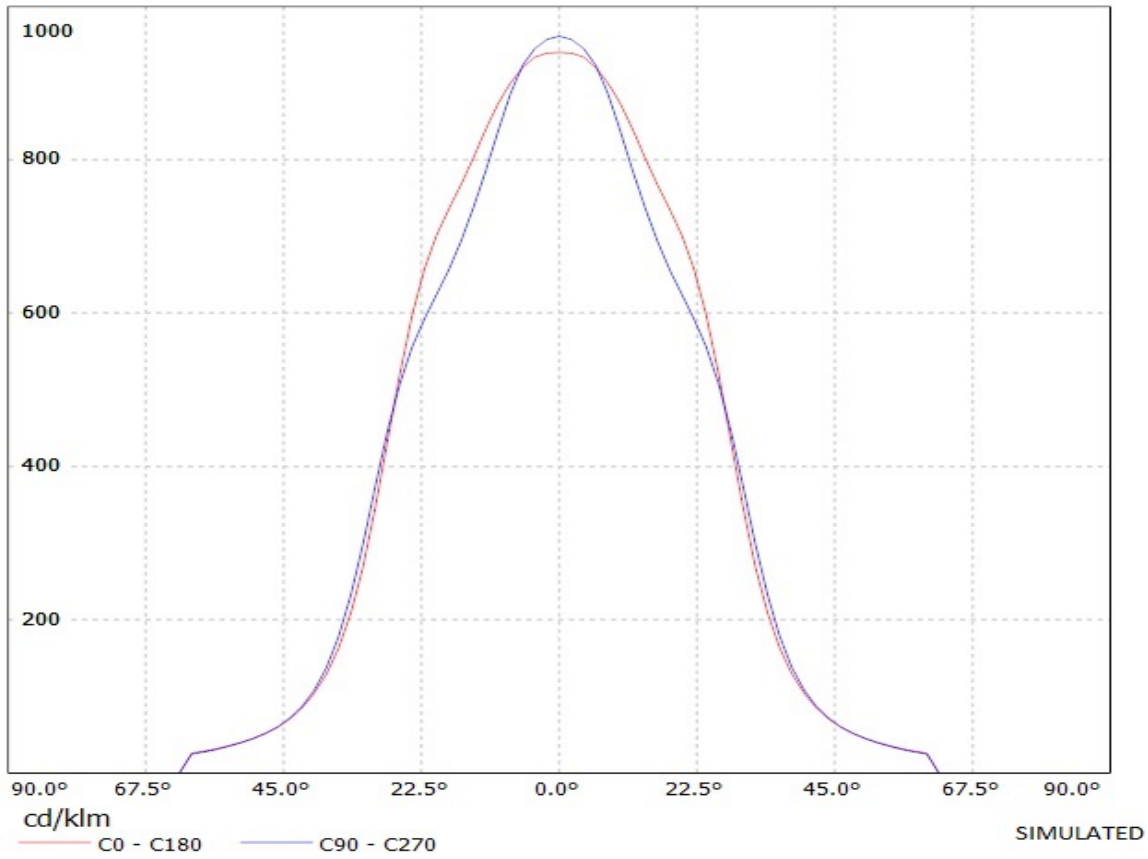

# Ledil Oy C11624\_GT3-OSL150-WW C11624\_GT3-OSL150-WW / LDC (Linear)

Luminaire: Ledil Oy C11624\_GT3-OSL150-WW C11624\_GT3-OSL150-WW  
Lamps: 1 x Osram OSL 150 deg white

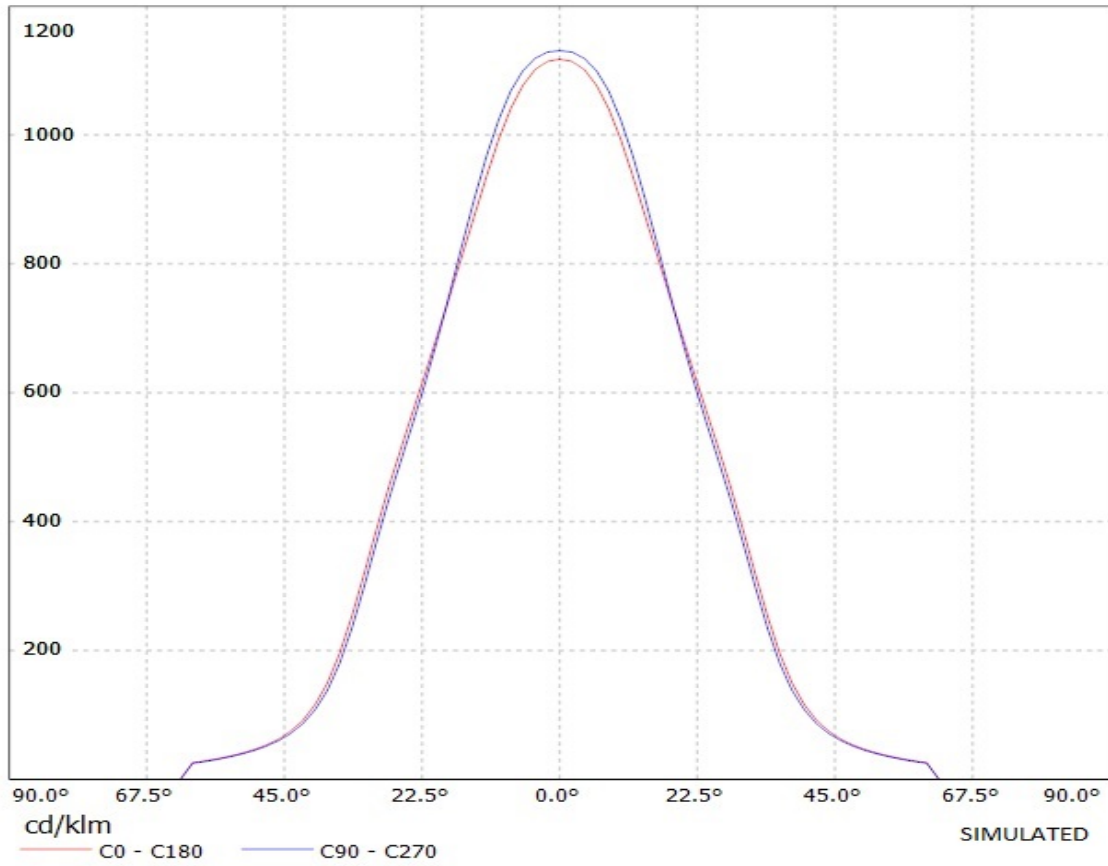



# Ledil Oy C11624\_GT3-XP-WW C11624\_GT3-XP-WW / LDC (Polar)

Luminaire: Ledil Oy C11624\_GT3-XP-WW C11624\_GT3-XP-WW

Lamps: 1 x Cree XP-E x3 white

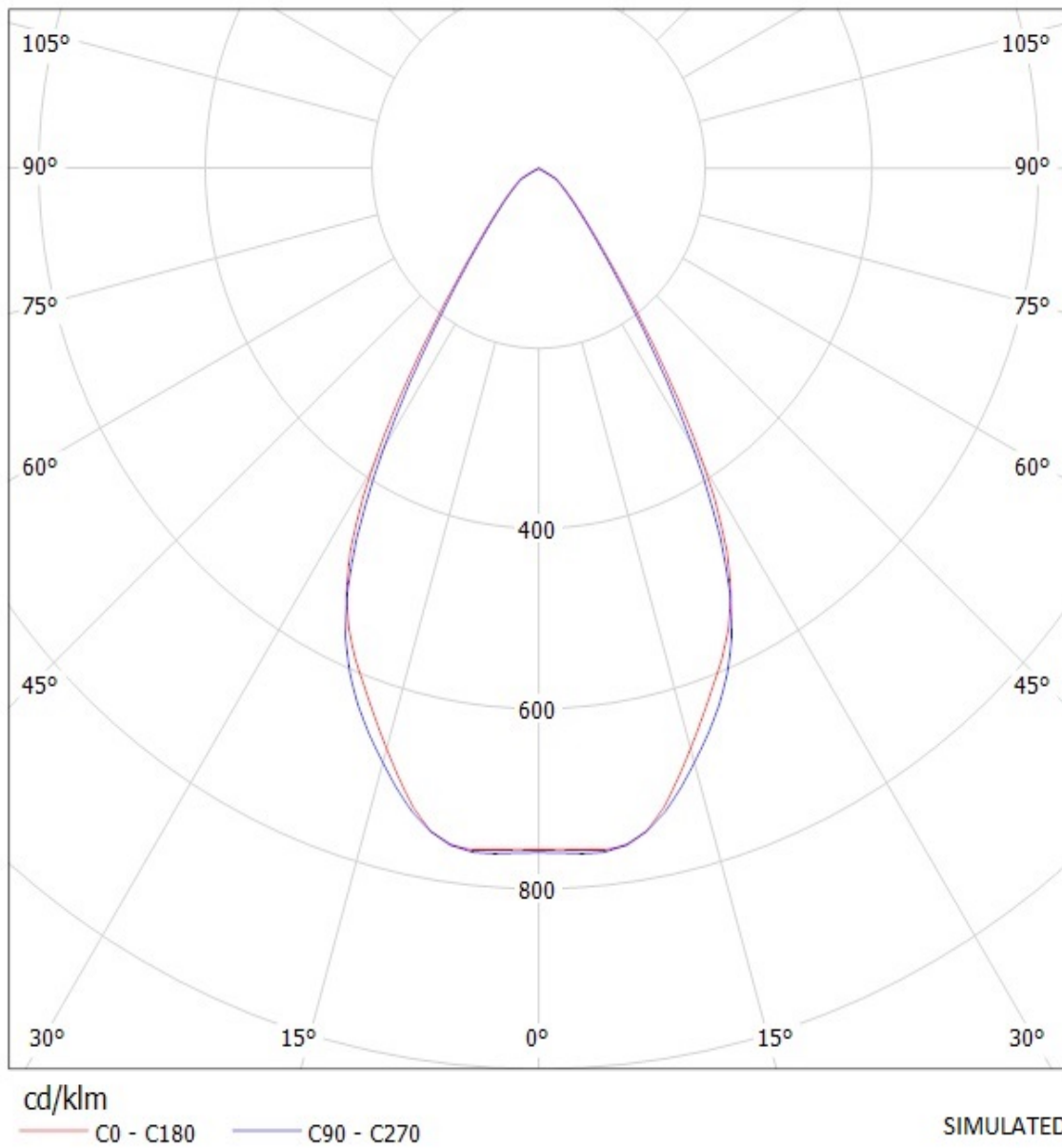

# Ledil Oy C11624\_GT3-XP-G-WW C11624\_GT3-XP-G-WW / LDC (Polar)

Luminaire: Ledil Oy C11624\_GT3-XP-G-WW C11624\_GT3-XP-G-WW

Lamps: 1 x Cree XP-G x3 white

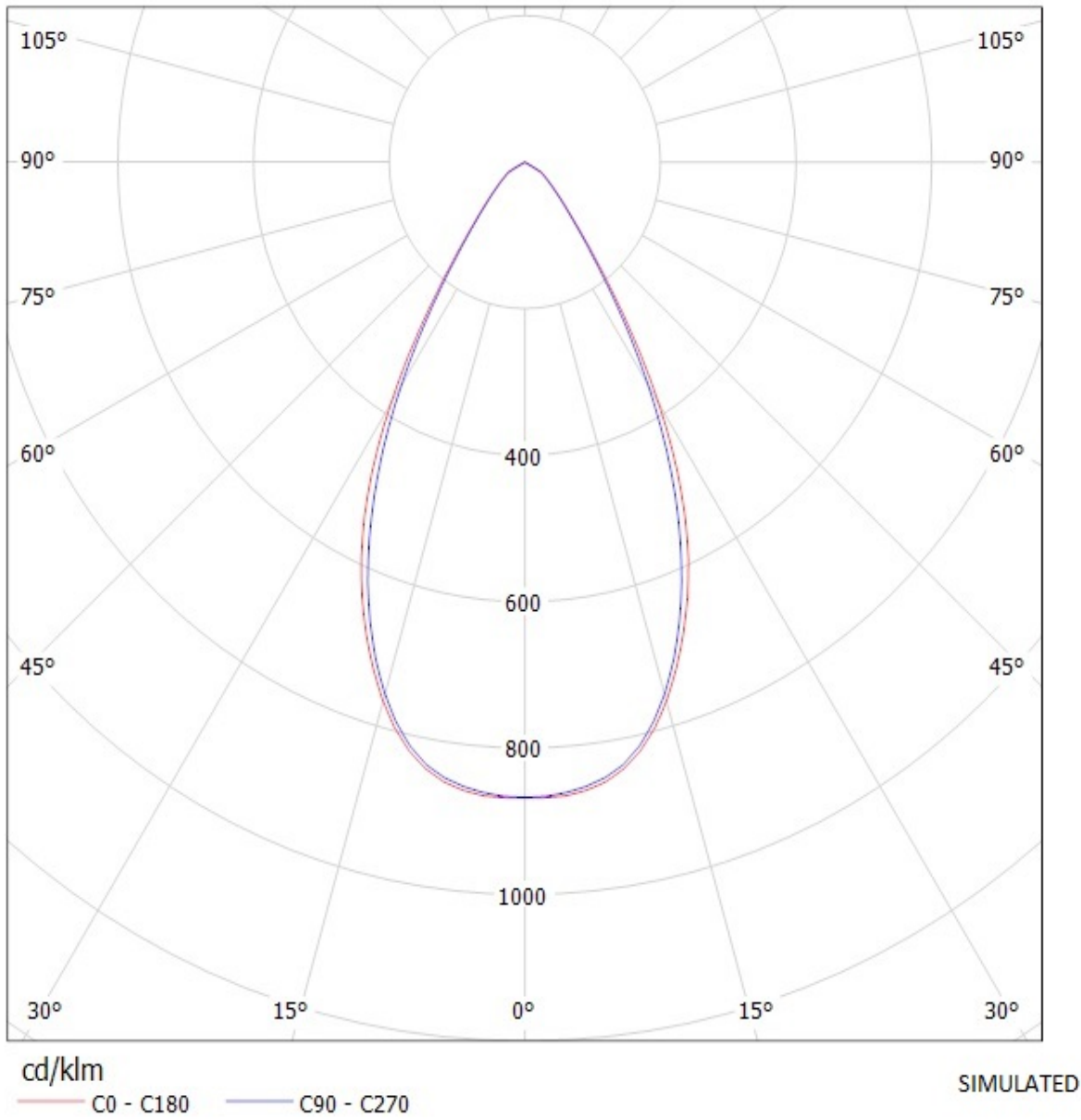

# Ledil Oy C11624-GT3-RE-ES-WW C11624-GT3-RE-ES-WW / LDC (Polar)

Luminaire: Ledil Oy C11624-GT3-RE-ES-WW C11624-GT3-RE-ES-WW

Lamps: 1 x Luxeon-Rebel-ES x3

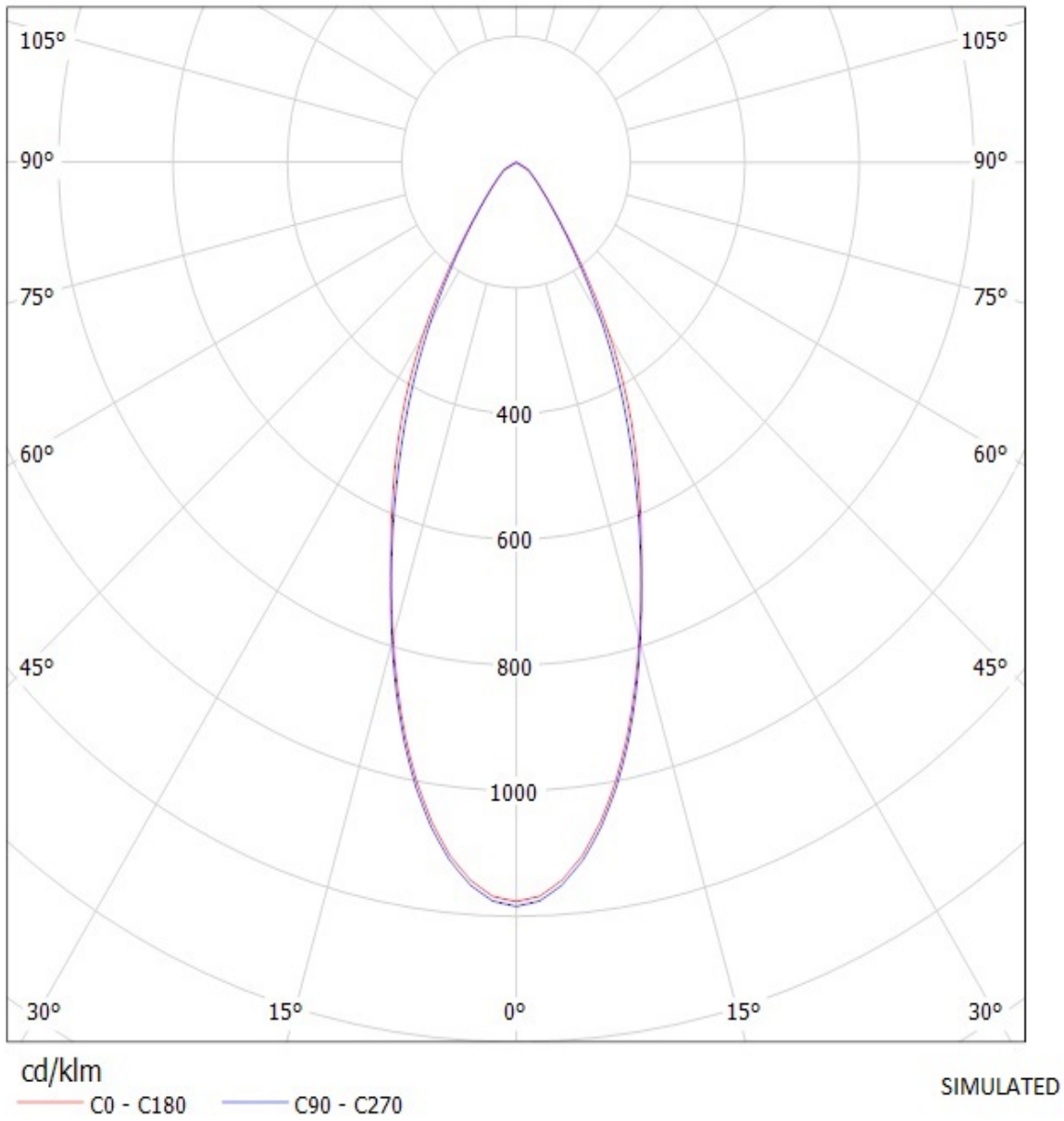

# Ledil Oy C11624\_GT3-OSL-WW C11624\_GT3-OSL-WW / LDC (Polar)

Luminaire: Ledil Oy C11624\_GT3-OSL-WW C11624\_GT3-OSL-WW

Lamps: 1 x Osram OSL 80 deg x3 whit

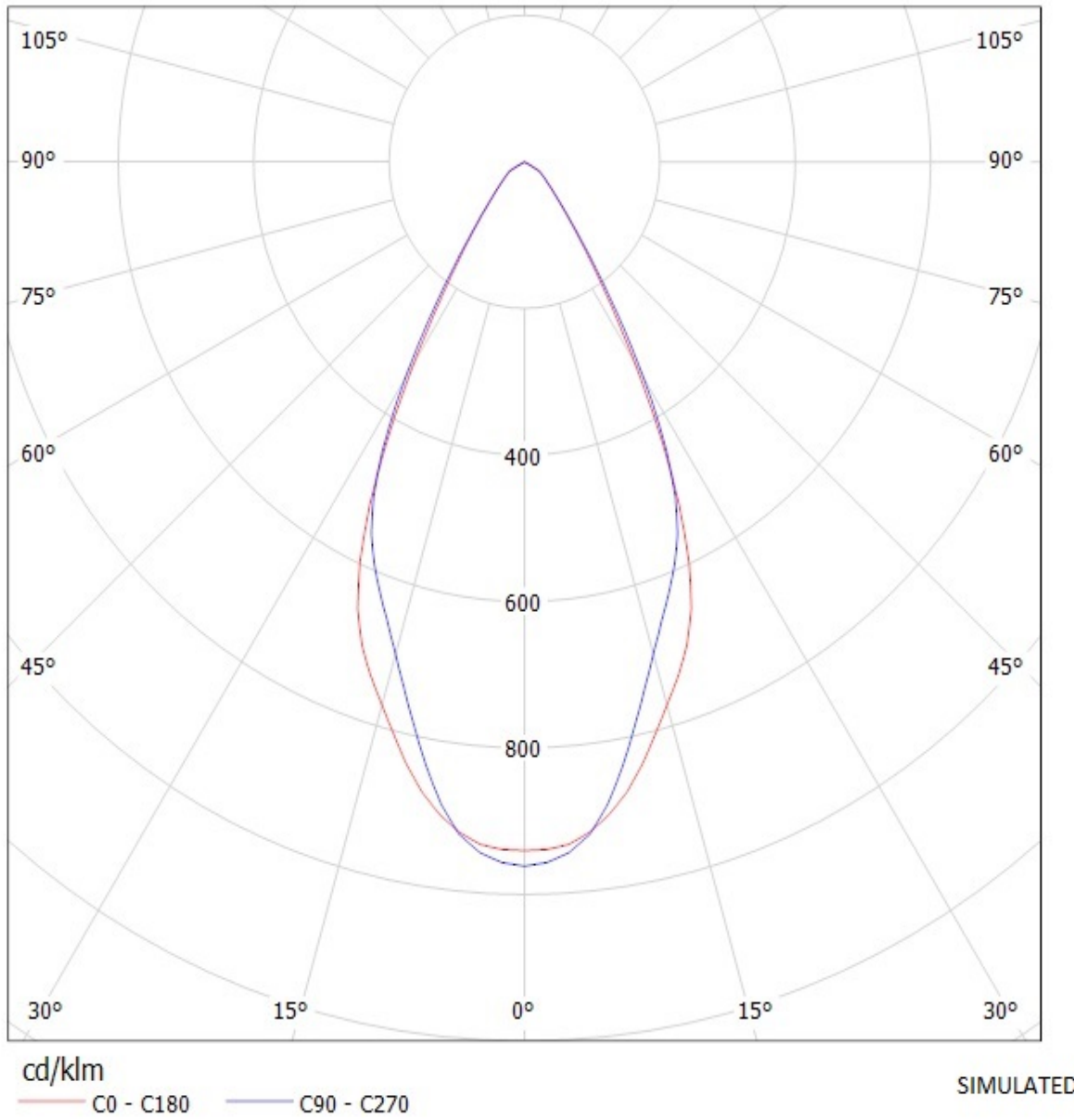

# Ledil Oy C11624\_GT3-OSL150-WW C11624\_GT3-OSL150-WW / LDC (Polar)

Luminaire: Ledil Oy C11624\_GT3-OSL150-WW C11624\_GT3-OSL150-WW

Lamps: 1 x Osram OSL 150 deg white

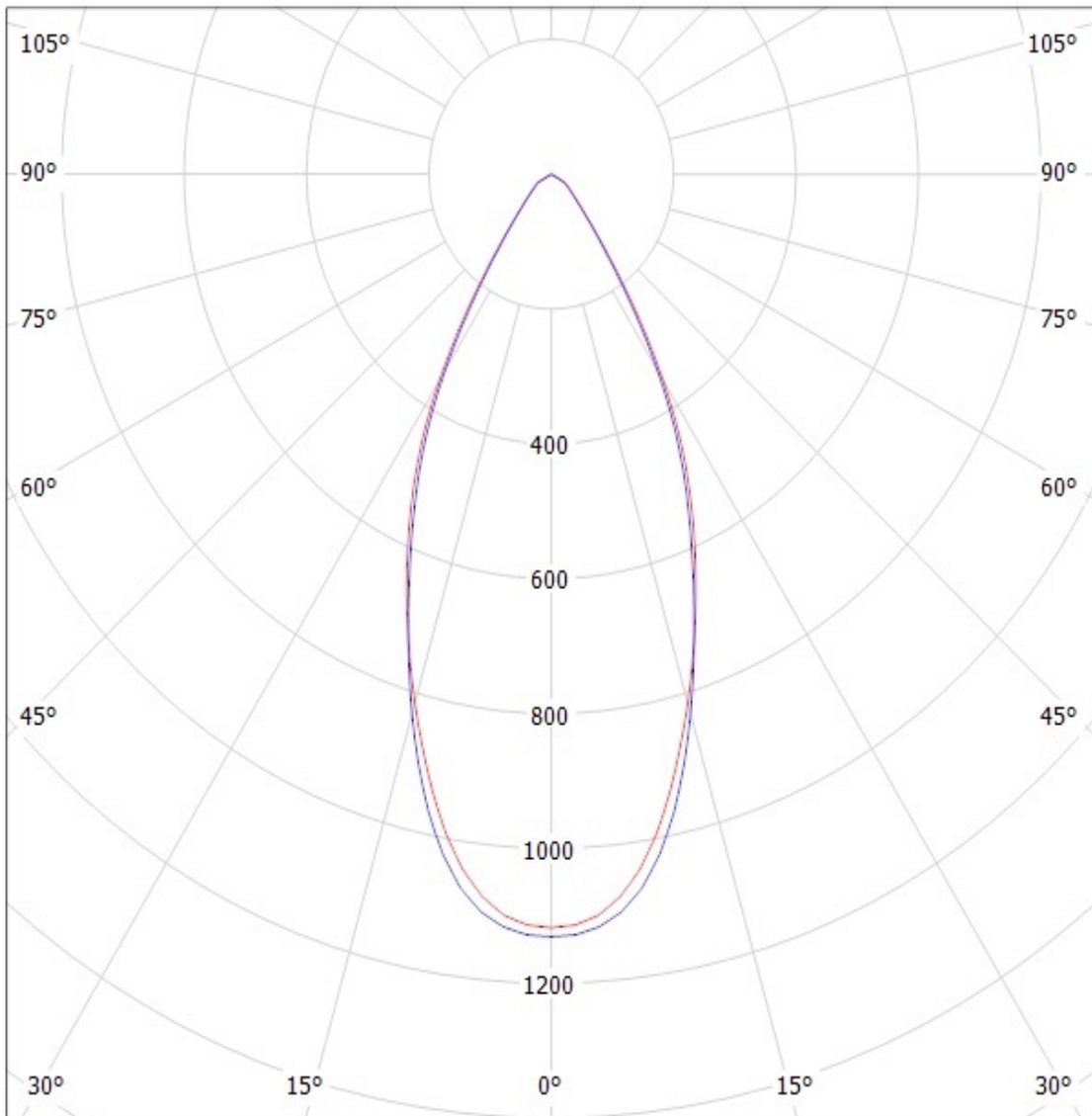

cd/klm

— C0 - C180 — C90 - C270

SIMULATED

Luminaire: Ledil Oy C11624\_GT3-WW-EC (Osram Oslon Square EC 224Lm @ 250mA)  
Lamps: 1 x Osram Oslon Square EC 224Lm @ 250mA

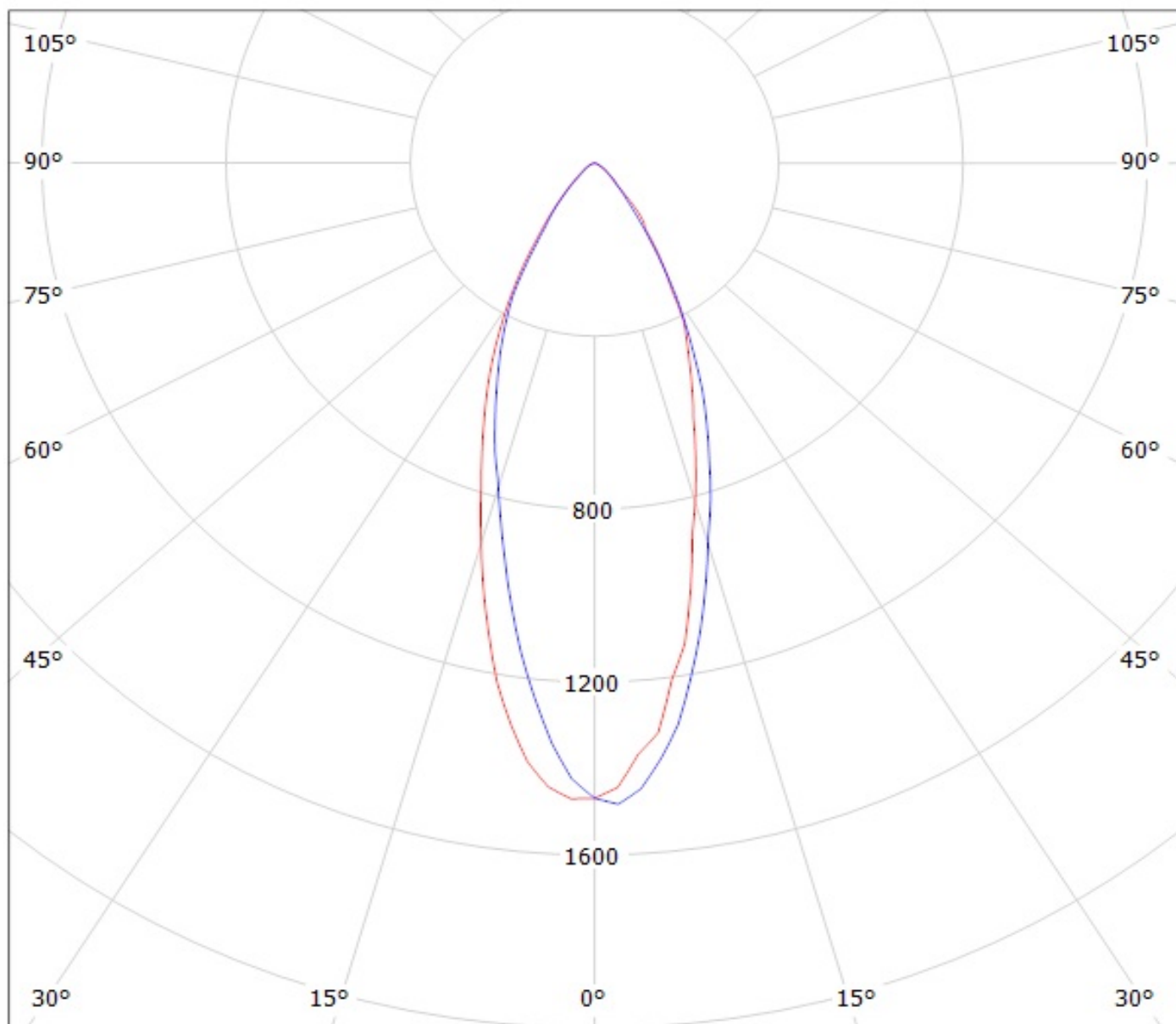

cd/klm

— C0 - C180

— C90 - C270

**NOTE: The typical divergence will be changed by different color, chip size and chip position tolerance. The typical total divergence is the full angle measured where the luminous intensity is half of the peak value.**