

DATE: 2022.08.05  
SPEC.NO: SICE-SP-S036

To: MARITEX

# SPECIFICATION

FOR AL. ELECTROLYTIC CAPACITORS (RFX SERIES)

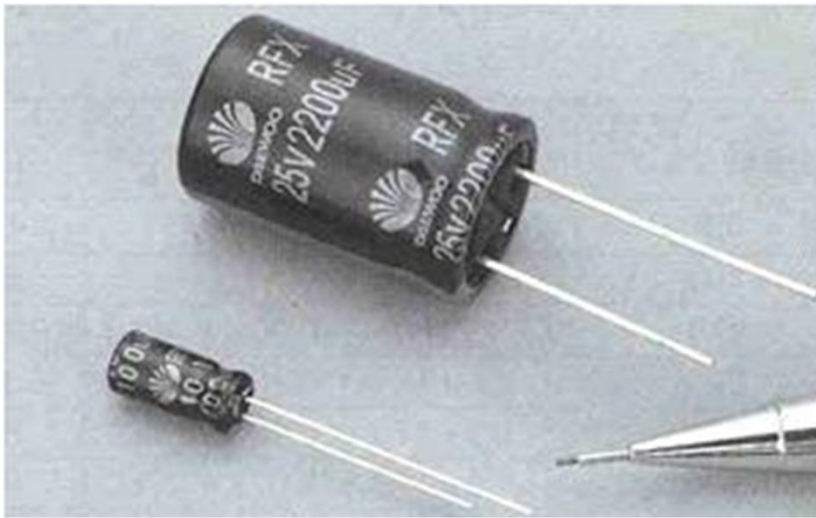

- RFX1J561MIAV  
(12.5\*25)

Please return us one copy your signed specification after you approved of it

**MANUFACTURE: DAEWOO ELECTRONIC EQUIPMENT CO., LTD VIET NAM**

SUPPLIER'S DAEWOO

Maker	Checker	Approval



CUSTOMER'S MARITEX

Maker	Checker	Approval

SICE-SP-S036	APPROVAL DATA FOR ELECTROLYTIC CAPACITOR	REV. Date	2022.08.05
DAEWOO ELECTRONIC EQUIPMENT VIETNAM CO., LTD		REV. No	0
		Page	1 of 10

We hand in this specification order to be approved of electrolytic capacitor (RFX Series) that our company is going to deliver your company.

1. Composition Type: RFX1J561MIAV "12.5x25"

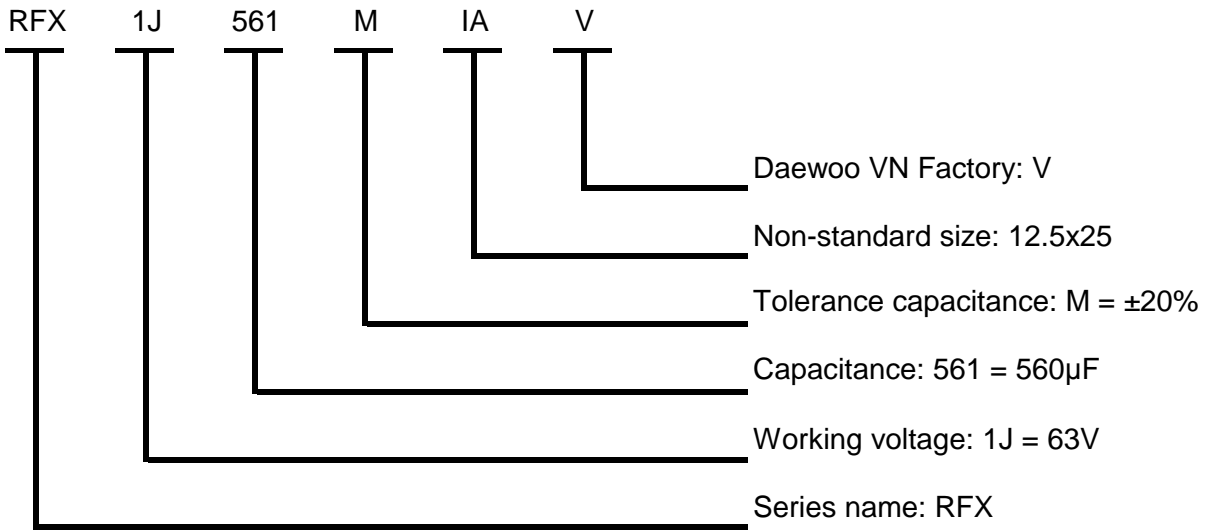

2. Operating temperature range:

63WV: -55°C to +105°C (-67°F to +185°F)

3. Electrical characteristic:

3.1 Capacitance.

The capacitance is measured at a frequency of 120Hz at a temperature of 20°C ± 2°C (68°F ± 3.6°F) with a maximum of 0.5 Vrms applied.

Capacitance tolerance	-20% ~ +20% (M)
-----------------------	-----------------

3.2 Leakage current (L.C)

I	≤ 0.01CV (1min) or 3µA( 2min)
---	-------------------------------

I = DC Leakage current (µA)

C = Nominal capacitance (µF)

V = Rated Voltage (WV.DC)

SICE-SP-S036	APPROVAL DATA FOR ELECTROLYTIC CAPACITOR	REV. Date	2022.08.05
DAEWOO ELECTRONIC EQUIPMENT VIETNAM CO.,LTD		REV. No	0
		Page	2 of 10

### 3.3 Tangent of Loss Angle (Tan $\delta$ )

The tangent of the loss angle when measured at a frequency of 120Hz at a temperature of (20°C  $\pm$  2°C) (68°F  $\pm$  3.6°F) shall be less than the values indicated below:

Tan $\delta$ (max., at 20°C,120Hz)	W.V (V)	63
	Tan $\delta$	0.09

When capacitance is over 1000 $\mu$ F, Tan $\delta$  shall be added 0.02 to the listed value with increase of every each 1000 $\mu$ F.

## 4. Test.

### 4.1 Damp heat

The capacitor shall be stored at a temperature of 40  $\pm$  2°C and relative humidity of 90% to 95% for 240  $\pm$  8hours. And then the capacitor shall be subjected to standard atmospheric conditions for 01 to 02 hours, after which measurements shall be made.

Capacitance change	Within $\pm$ 20% of the initial value.
Tan $\delta$	Within value specified above.
Leakage current	Within value specified above.

### 4.2 Load life

After applying rated working voltage for 7000hours at +105°C and then being stabilized at + 20°C, capacitors shall meet following limits.

Capacitance change	Within $\pm$ 25% of the initial measured value.
Tan $\delta$	$\leq$ 200% of the initial specified value.
Leakage current	$\leq$ The initial specified value.

SICE-SP-S036	APPROVAL DATA FOR ELECTROLYTIC CAPACITOR	REV. Date	2022.08.05
DAEWOO ELECTRONIC EQUIPMENT VIETNAM CO.,LTD		REV. No	0
		Page	3 of 10

#### 4.3 Shelf life

After storage for 1000 hours at +105°C with no voltage applied and then being stabilized at +20°C capacitors shall meet following limits.

Capacitance change	Within $\pm 25\%$ of the initial measured value.
Tan $\delta$	$\leq 200\%$ of the initial specified value.
Leakage current	$\leq 200\%$ of the initial specified value.

#### 4.4 Impedance ratio at low temperature

When capacitor are stored at the temperature of  $-40^{\circ}\text{C} \pm 3^{\circ}\text{C}$  and  $20^{\circ}\text{C} \pm 2^{\circ}\text{C}$  respectively the ratio of impedance measured at each test temperature with the frequency of 120 Hz shall be less than value.

W.V (V)	63
Z-40°C/Z20°C	3

#### 4.5 Resistance to soldering heat

For other procedures than those specified below soldering iron method.

+ Temperature:  $260 \pm 5^{\circ}\text{C}$

+ Application time of soldering iron :10 sec

Capacitance change	Within $\pm 20\%$ of the initial value.
Tan $\delta$	Within values specified above .
Leakage current	Within values specified above .

SICE-SP-S036	<b>APPROVAL DATA FOR ELECTROLYTIC CAPACITOR</b>	REV. Date	2022.08.05
DAEWOO ELECTRONIC EQUIPMENT VIETNAM CO.,LTD		REV. No	0
		Page	4 of 10

5. Recommended cleaning solvents

Methanol, isopropanol, isobutanol, ethanol, petroleum ether, propanol and or commercial detergents.

Halogenated hydrocarbon cleaning agents such as freon (MF, TF, TMC or TC) trichloroethylene, trichloroethane, or methylchloride are not recommended as they may damage the capacitor.

6. Marking

The following items shall be marked indelibly and legibly on the specified location.

- 1). Brand: DAEWOO
- 2). Series Designation: RFX
- 3). Rated Voltage (DC): 63V
- 4). Capacitance( $\mu$ F): 560 $\mu$ F
- 5). Capacitance Tolerance(M):  $\pm$ 20%
- 6). Maximum Operating Temperature: 105°C
- 7). Lot No: 0N
- 8). Sleeve Colour: BLACK

7. Lot Number

The lot number regulates the following formula. But 1, 0, I are exception

Ex: Jan 2020

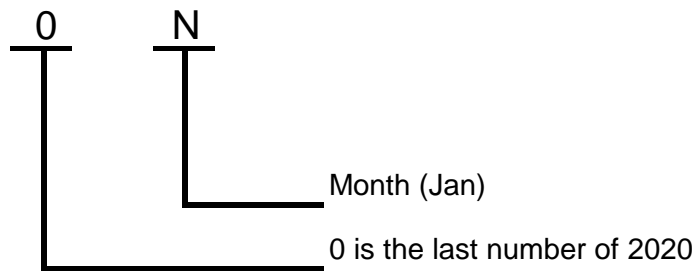

MONTH	1	2	3	4	5	6	7	8	9	10	11	12
YEAR												
2020	N	P	Q	R	S	T	U	V	W	X	Y	Z
2029												

SICE-SP-S036	APPROVAL DATA FOR ELECTROLYTIC CAPACITOR	REV. Date	2022.08.05
DAEWOO ELECTRONIC EQUIPMENT VIETNAM CO.,LTD		REV. No	0
		Page	5 of 10

8. CASE SIZE AND DIMENSION  
Insulating Sleeve

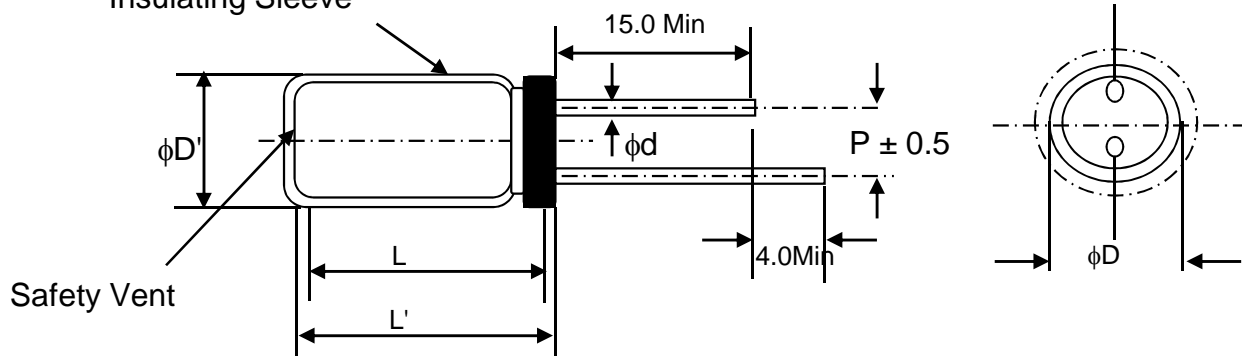

\* Standard lead style:

$\phi D$	12.5
P	5.0
$\phi d$	0.6

$$D' = [D + 0.5] \text{Max}$$

$$L' = [L + 1.0] \text{Max. at } D \leq 8.0$$

$$L' = [L + 1.5] \text{Max. at } D \geq 10.0$$

9. RIPPLE CURRENT COEFFICIENT

\* Frequency

Freq(Hz)	120	1K	10K	100K
CAP( $\mu\text{F}$ )				
560 $\mu\text{F}$	0.55	0.77	0.94	1.0

\* Temperature

Temperature	$\leq 70^\circ\text{C}$	$85^\circ\text{C}$	$105^\circ\text{C}$
Factor	2.10	1.70	1.00

10. DIMENSION & PERMISSIBLE RIPPLE CURRENT [mA(rms) at  $105^\circ\text{C}$ , 100KHz]

WV (V)	CAP ( $\mu\text{F}$ )	SIZE	Z( $\Omega$ ,100KHz)	RIPPLE CURRENT
63	560	12.5 x 25	0.048	2530

SICE-SP-S036	APPROVAL DATA FOR ELECTROLYTIC CAPACITOR	REV. Date	2022.08.05
DAEWOO ELECTRONIC EQUIPMENT VIETNAM CO.,LTD		REV. No	0
		Page	6 of 10

### 11. Packing method

11.1 Taped products shall be packed in a cardboard box like zigzag.

There shall be a single part number in a inner carton.

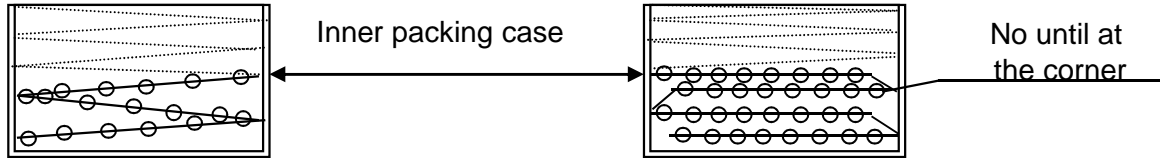

11.2 Polarity identifications on a cardboard box shall match the polarity of products.

11.3 Inner carton box shall be handled as follows.

- \* No more than 10 inner carton boxes shall be piled.
- \* In case of putting the boxes lengthways, the indication of porarity shall face up.
- \* The products shall be handled with care.

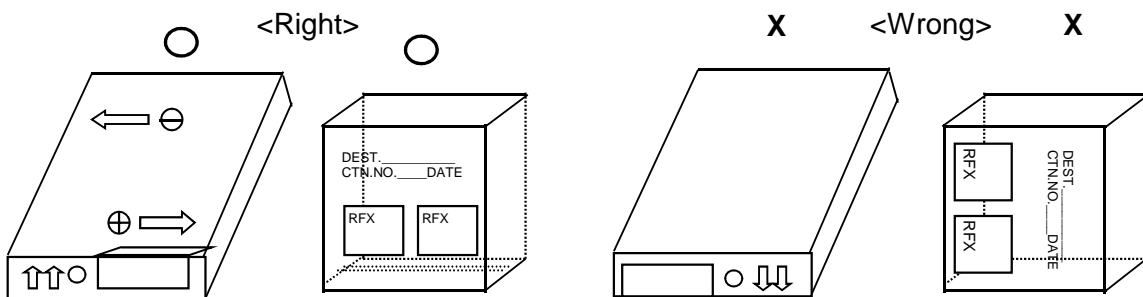

11.4 The inner cartons shall be packed in a cardboard box for transportation.

Various part number can be packed in a outer carton.

11.5 Shape & dimensions of inner carton shall be as follows.

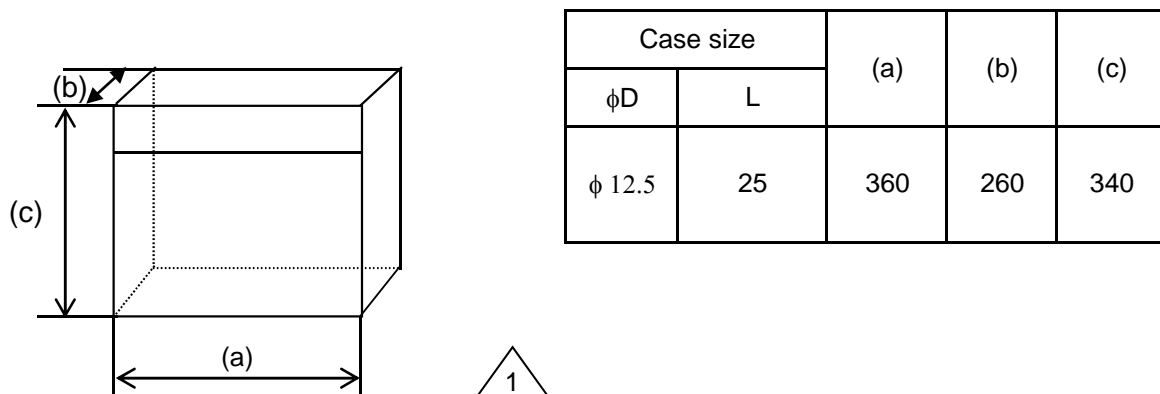

\* **Note:** The dimensions listed above may be changed without notice. The carton shall be suitable for the auto-insert machines after change.

SICE-SP-S036	<b>APPROVAL DATA FOR ELECTROLYTIC CAPACITOR</b>	REV. Date	2022.08.05
DAEWOO ELECTRONIC EQUIPMENT VIETNAM CO.,LTD		REV. No	1
		Page	7 of 10

\* Inner box packing standard:

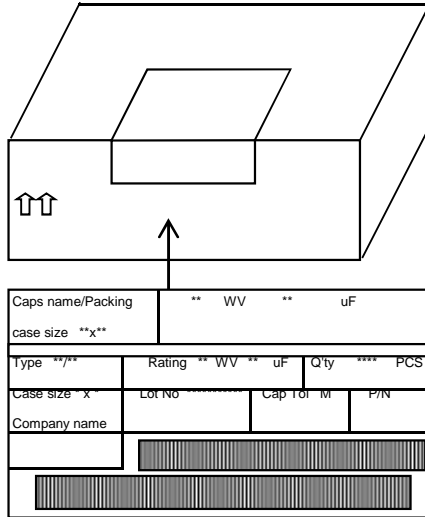

11.6 Packing standard quantity:

Product diameter [mm]	Inner carton quantity min. Packing quantity [Pcs]	Outer carton quantity [Pcs]
φ 12.5 x 25	1000	2000



SICE-SP-S036	APPROVAL DATA FOR ELECTROLYTIC CAPACITOR	REV. Date	2022.08.05
DAEWOO ELECTRONIC EQUIPMENT VIETNAM CO.,LTD		REV. No	0
		Page	8 of 10

12.CONSTRUCTION RADIAL TYPE CAPACITORS.

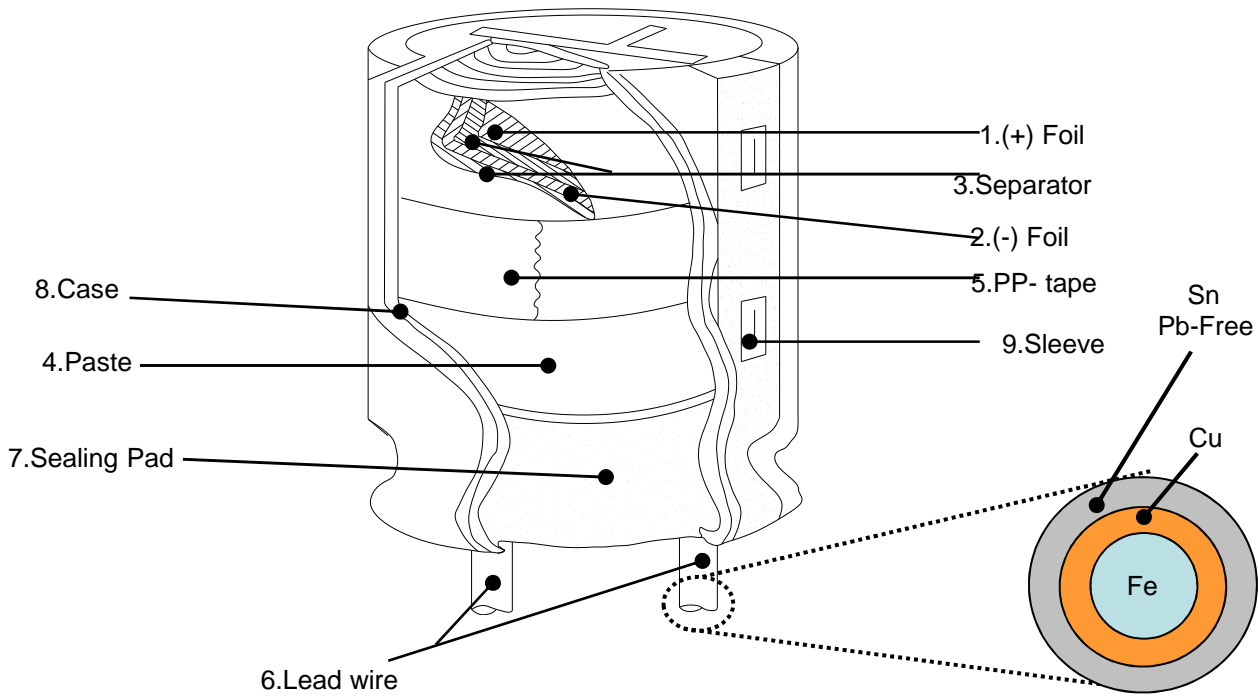

No	Raw Materials			Contents(ppm=mg/kg)						ICP Data
	Part Name	Vendor	Material	cd	pb	Hg	Cr6+	PBB	PBDE	
1	FOIL(+)	HAIXING, HFCC	Aluminium	0	0	0	0	0	0	#1
2	FOIL(-)	ELE-CON	Aluminium	0	0	0	0	0	0	#2
3	Paper	KAN	Pulp	0	0	0	0	0	0	#3
4	PASTE	CAPCHEM	MEG	0	0	0	0	0	0	#4
5	Adhesive Tape	TAPEX	Polypropylene	0	0	0	0	0	0	#5
6	Lead wire	LITON	Al,Fe+Sn	0	0	0	0	0	0	#6
7	Rubber	LIEN EKI	Rubber	0	0	0	0	0	0	#7
8	Case	OAKLEY	Aluminium	0	0	0	0	0	0	#8
9	Sleeve	MOODEUNG	PET	0	0	0	0	0	0	#9
10	Sleeve Ink	MOODEUNG	INK	0	0	0	0	0	0	#10
11	Box Packing	TRUONG HUNG	Kraft	0	0	0	0	0	0	#11
TOL				0	0	0	0	0	0	
SAMSUNG Eco-Partner Standard				5	100	800	800	100	100	

SICE-SP-S036		APPROVAL DATA FOR ELECTROLYTIC CAPACITOR		REV. Date	2022.08.05
DAEWOO ELECTRONIC EQUIPMENT VIETNAM CO.,LTD				REV. No	0
				Page	9 of 10
<b>RAW MATERIAL SUPPLIERS LIST</b>					
Items	Company name	Country	Contents	Using of CE	Remark
Anode Foil	- HFCC	- CHINA	* Low and high gain Anode Foil	* All series of CE	* Forming(+)
	- HAIXING	- CHINA	* High voltage (160Fv up) Foil		
Cathode Foil	- ELE-CON	- CHINA	* Cathode Foil (20, 40, 50 $\mu$ m)	* All series of CE	* Etching(-) * PURITY : 98.4%
Lead wire	- LITON	- CHINA	* Lead-wire welding and press	* 04 type only	* Sn 100% coated
Case	- OAKLEY	- CHINA	- 04 ~ 18 Al-case press	* All series of CE	
Sleeve	- MOODEUNG	- KOREA	* PET tube	* 04, Snap-in all	
Paper	- KAN	- CHINA	* 100% from CHINA	* All series of CE	
Rubber	- LIEN EKI	- MALAYSIA	* Normal and butyl Rubber	* All series of CE	
Paste	- CAPCHEM	- CHINA	* Adipic Acid, Boric Acid	* All series CE	
Adhesive Tapex	- TAPEX	- KOREA	* Element winding film	* 04, Snap-in all	