



PC30H08 V1

Product Specification

Approval Sheet

PC30H08 V1

Product Specification

RoHS

Product	White SMD LED
Part Number	PC30H08 V1
Issue Date	2016/06/20



■ Feature

- ✓ White SMD LED (L x W x H) of 3.0 x 1.4 x 0.65 mm
- ✓ ASNI Binning
- ✓ Dice Technology : InGaN
- ✓ Qualified according to JEDEC moisture sensitivity Level 3
- ✓ Environmental friendly ; RoHS compliance
- ✓ Packing : 2000 or 4000 pcs/reel

■ Applications

- ✓ Portable flashlight
- ✓ Reading lights
- ✓ Security / garden lighting
- ✓ General lighting
- ✓ Indoor and outdoor commercial lighting

Outline Dimension

PC30H08 V1
Product Specification

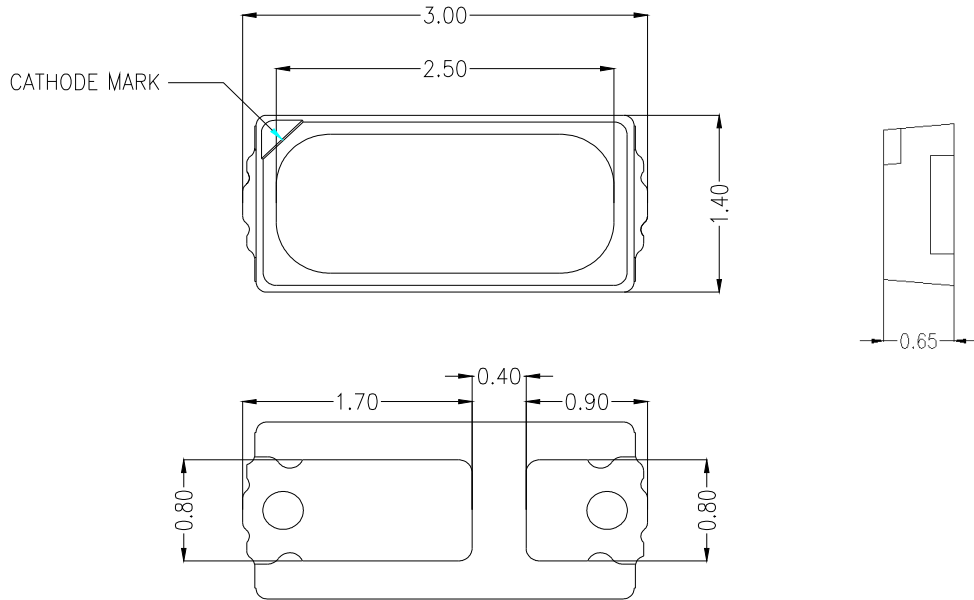

Unit: mm, Tolerance: ± 0.1 mm

■ Recommended Soldering Pad:

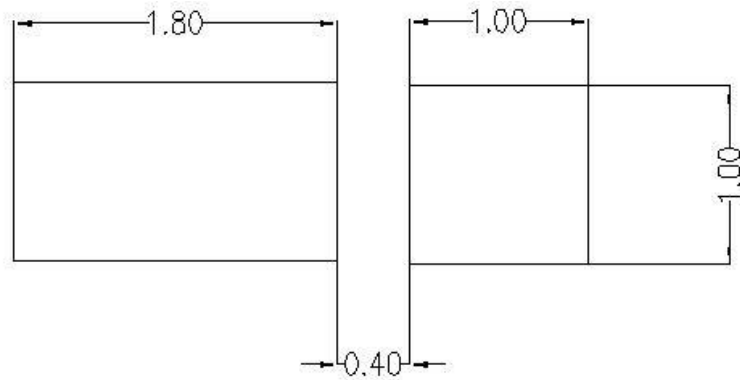

Performance

PC30H08 V1
 Product Specification

Electro-Optical Characteristics (Ta=25°C)

Parameter	Symbol	Condition	Min.	Typ.	Max.	Unit
Forward Voltage ⁽¹⁾	V _F	I _F = 65 mA	2.8	3.08	3.4	V
Color Rendering Index ⁽²⁾	R _a		80	-	-	-
View Angle	θ		-	120	-	deg
Thermal Resistance ⁽³⁾	R _{th}		-	45	-	°C/W

- (1) The Forward Voltage tolerance is ±0.1V
- (2) The CRI tolerance is ±2.
- (3) Thermal resistance is calculated from junction to solder

Luminous Flux (Ta=25°C)

CCT	Condition	Rank
2600K~3700K	I _F = 65 mA	TE ,TF , TG
3700K~7000K		TF, TG, TH

* The luminous flux tolerance is ± 7%

Absolute Maximum Ratings

Parameter	Symbol	value	Unit
DC Forward Current ⁽¹⁾	I _F	150	mA
Power Dissipation	P _d	0.5	W
Pulse Forward Current ⁽²⁾	I _{FP}	200	mA
Storage Temperature	T _s	-40 ~ 100	°C
Operating Temperature	T _{opr}	-40 ~ 85	°C
Junction Temperature	T _J	120	°C
Soldering Temperature	T _{sol}	260 (max. 5 sec)	°C

- (1) Proper current rating must be observed to maintain junction temperature below maximum at all time
- (2) IFP Condition: Duty 1/10, Pulse within 10msec

Ordering Code

P C 3 0 H 0 8 1 - A 2 7 0 C 0 T E T G 0 5 - 0 0 0

1	2	3	4	5	6	7	8	9	10	11	12	13	14	15	16	17	18	19	20	21	22	23
---	---	---	---	---	---	---	---	---	----	----	----	----	----	----	----	----	----	----	----	----	----	----

Item	Pos.	Code	Spec	
Model Name	1-8	PC30H081	PC30H08 V1	
CIE Center Point	9	A	ANSI 1931 ellipse bin on B.B.L	
CCT	10,11	27	27 = 2700K	
		30	30 = 3000K	
		35	35 = 3500K	
		40	40 = 4000K	
		50	50 = 5000K	
		57	57 = 5700K	
		65	65 = 6500K	
Ra	12	0	Ra > 80	
CIE Bin Group ⁽¹⁾	13,14	A0	27A	
		B0	27A,27B,27C,27D,27E	
		C0	27A,27B,27C,27D,27E,27F,27G,27H,27I	
IV Bin Group	15,16,	TETG	Bin code : TE,TF,TG	
	17,18	TFTH	Bin code : TF,TG,TH	
Vf Bin Group	19,20	05	Bin code : 0,1,2,3,4,5	
Kitting	CIE ⁽¹⁾	21	0	No requirements.
Rules	IV	22	0	No requirements.
	Vf	23	0	No requirements.

(1) The first two digits 27 means CCT in 2700K, can be replaced to 30, 35, 40, 50, 57, 65 for different CCT requirements.

(2) Only under an agreement between customer and Lextar Electronics, kitting rules besides "0" can be supplied.

■ **Standard Ordering Code:**

CCT	Ordering Code ⁽¹⁾	CIE Bin Group	IV Bin Group	Vf Bin Group
2700K	PC30H081-A271A0TETG05-000	A0	TE,TF,TG	0,1,2,3,4,5
	PC30H081-A271B0TETG05-000	B0		
	PC30H081-A271C0TETG05-000	C0		
3000K	PC30H081-A301A0TETG05-000	A0	TE,TF,TG	0,1,2,3,4,5
	PC30H081-A301B0TETG05-000	B0		
	PC30H081-A301C0TETG05-000	C0		
3500K	PC30H081-A351A0TETG05-000	A0	TE,TF,TG	0,1,2,3,4,5
	PC30H081-A351B0TETG05-000	B0		
	PC30H081-A351C0TETG05-000	C0		
4000K	PC30H081-A401A0TFTH05-000	A0	TF,TG,TH	0,1,2,3,4,5
	PC30H081-A401B0TFTH05-000	B0		
	PC30H081-A401C0TFTH05-000	C0		
5000K	PC30H081-A501A0TFTH05-000	A0	TF,TG,TH	0,1,2,3,4,5
	PC30H081-A501B0TFTH05-000	B0		
	PC30H081-A501C0TFTH05-000	C0		
5700K	PC30H081-A571A0TFTH05-000	A0	TF,TG,TH	0,1,2,3,4,5
	PC30H081-A571B0TFTH05-000	B0		
	PC30H081-A571C0TFTH05-000	C0		
6500K	PC30H081-A651A0TFTH05-000	A0	TF,TG,TH	0,1,2,3,4,5
	PC30H081-A651B0TFTH05-000	B0		
	PC30H081-A651C0TFTH05-000	C0		

(1) Only under an agreement between customer and Lextar Electronics, Ordering codes not in "Standard Ordering Code Definitions" can be supplied.

Binning

PC30H08 V1

Product Specification

Chromaticity Coordinates

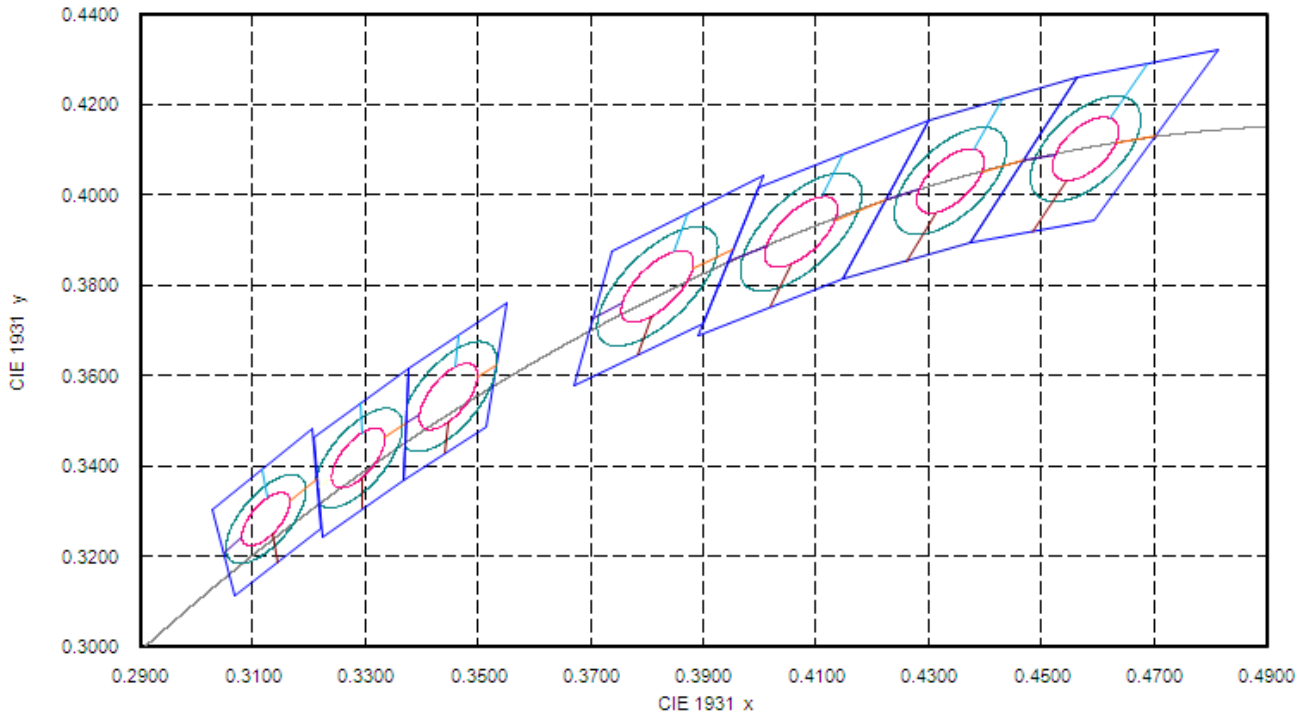

Bin code definition

V _F Rank	Luminous Flux Rank	CIE Rank
2	TE	27A

V _F Rank	Condition	Min.	Max.
0	I_F = 65 mA	2.8	2.9
1		2.9	3.0
2		3.0	3.1
3		3.1	3.2
4		3.2	3.3
5		3.3	3.4

Luminous Flux Rank	Condition	Min.	Max.	Unit
TD	$I_F = 65 \text{ mA}$	22	24	lm
TE		24	26	
TF		26	28	
TG		28	30	
TH		30	32	

■ Bin code definition

2700K

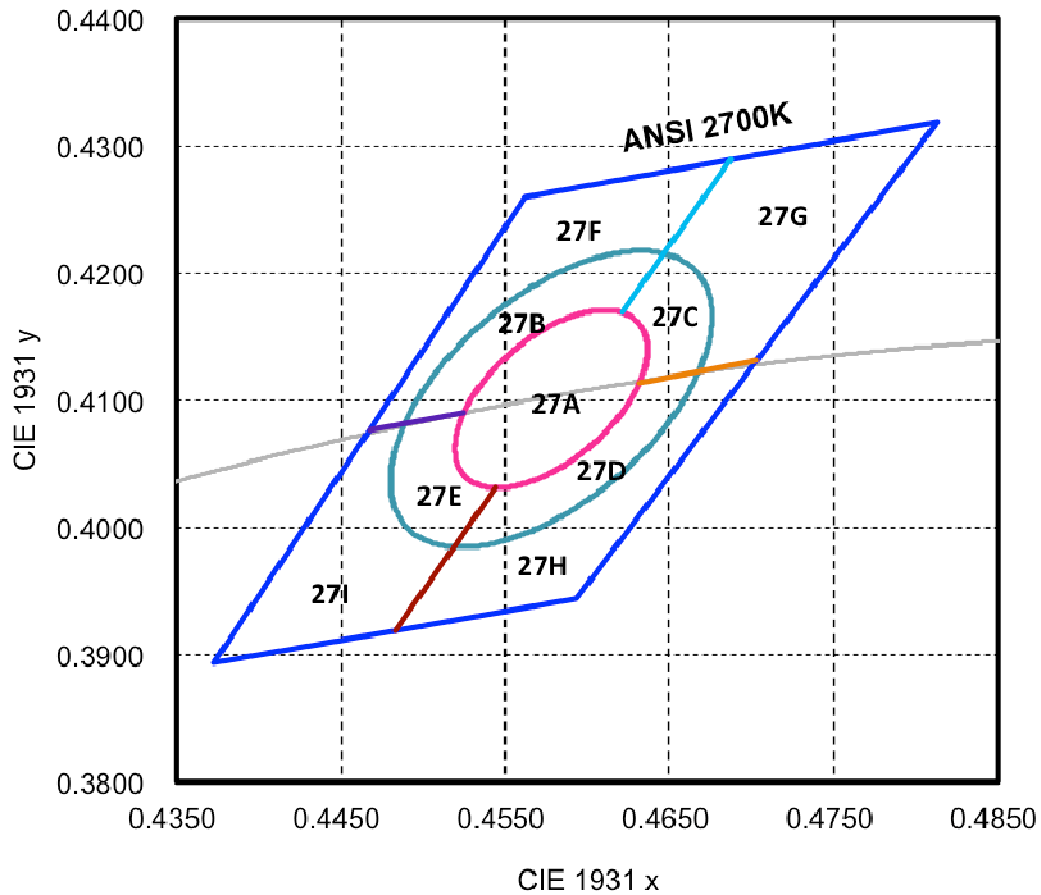

Nominal ANSI CCT	Color Space	Target Center Point (cx, cy)	Major Axis, a	Minor Axis, b	Ellipse Rotation Angle
2700K	Single 3-step MacAdam ellipse	(0.4578, 0.4101)	0.00810	0.00420	53.70°
2700K	Single 5-step MacAdam ellipse	(0.4578, 0.4101)	0.01350	0.00700	53.70°

3000K

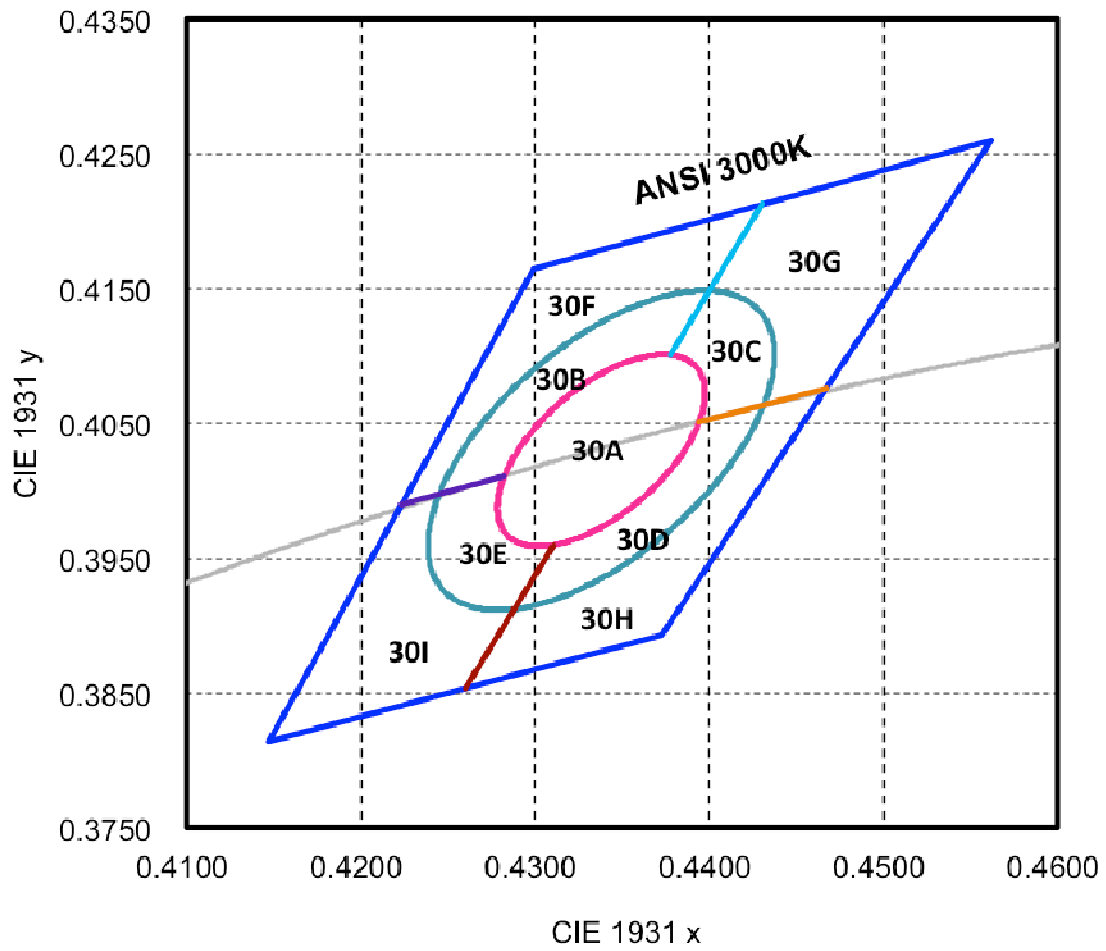

Nominal ANSI CCT	Color Space	Target Center Point (cx, cy)	Major Axis, a	Minor Axis, b	Ellipse Rotation Angle
3000K	Single 3-step MacAdam ellipse	(0.4338, 0.403)	0.00834	0.00408	53.22°
3000K	Single 5-step MacAdam ellipse	(0.4338, 0.403)	0.01390	0.00680	53.22°

3500K

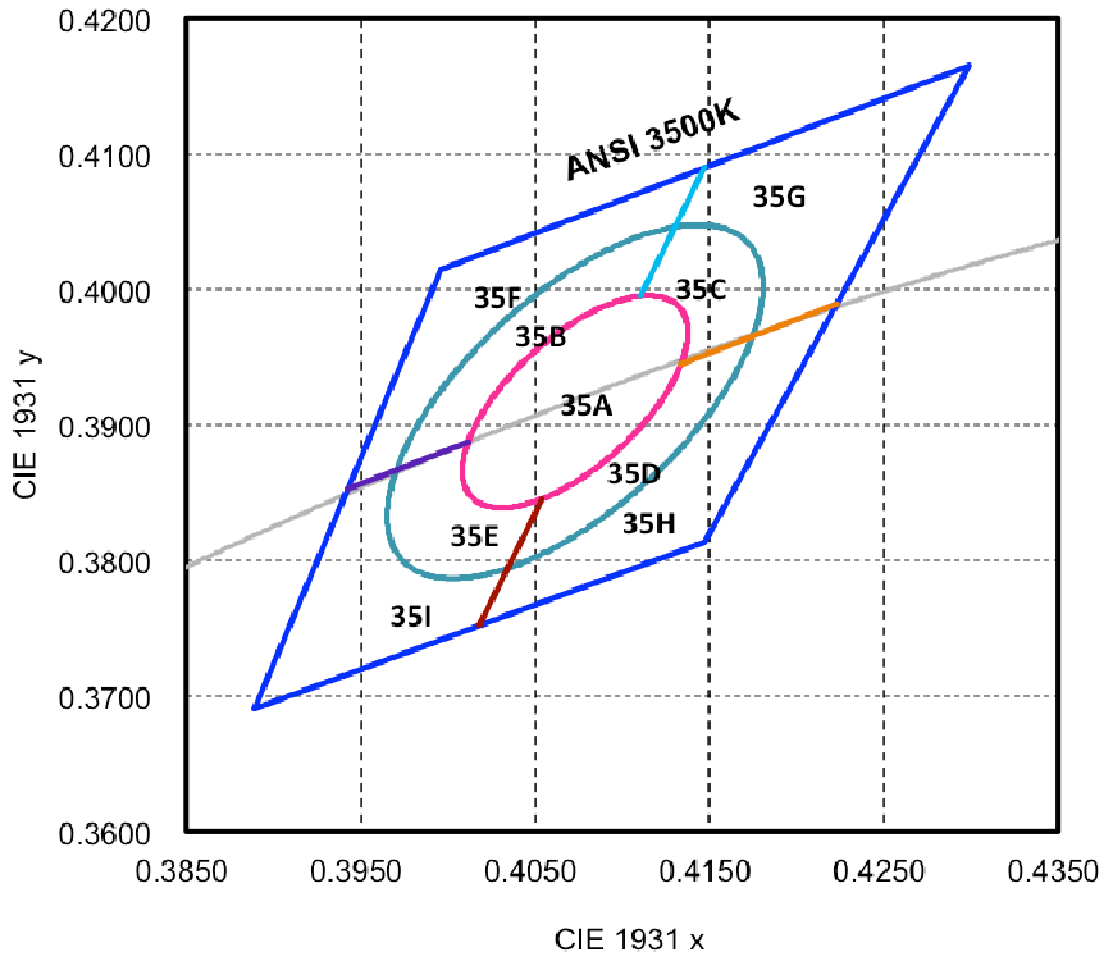

Nominal ANSI CCT	Color Space	Target Center Point (cx, cy)	Major Axis, a	Minor Axis, b	Ellipse Rotation Angle
3500K	Single 3-step MacAdam ellipse	(0.4073, 0.3917)	0.00927	0.00414	53.22°
3500K	Single 5-step MacAdam ellipse	(0.4073, 0.3917)	0.01545	0.00690	53.22°

4000K

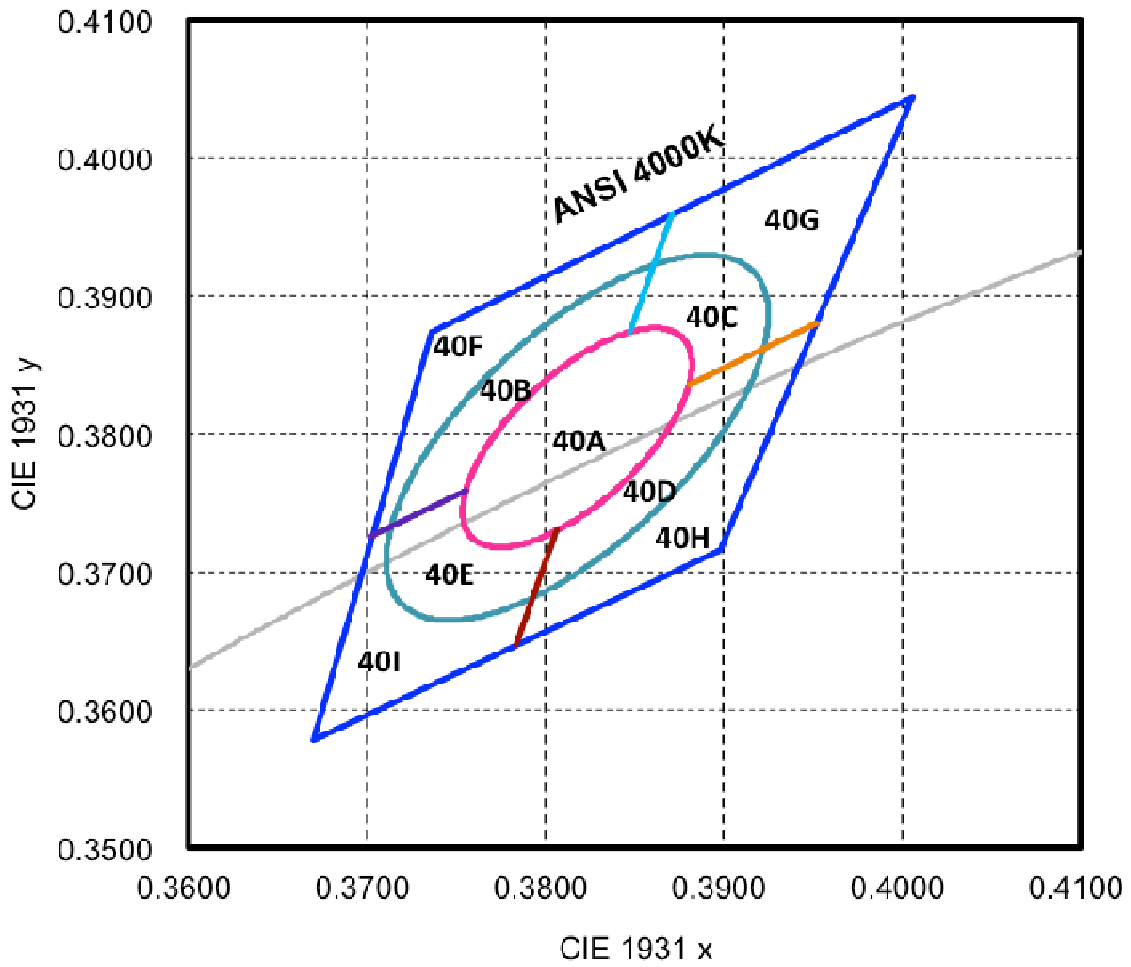

	Color Space	Target Center Point (cx, cy)	Major Axis, a	Minor Axis, b	Ellipse Rotation Angle
4000K	Single 3-step MacAdam ellipse	(0.3818, 0.3797)	0.00939	0.00402	53.72°
4000K	Single 5-step MacAdam ellipse	(0.3818, 0.3797)	0.01565	0.00670	53.72°

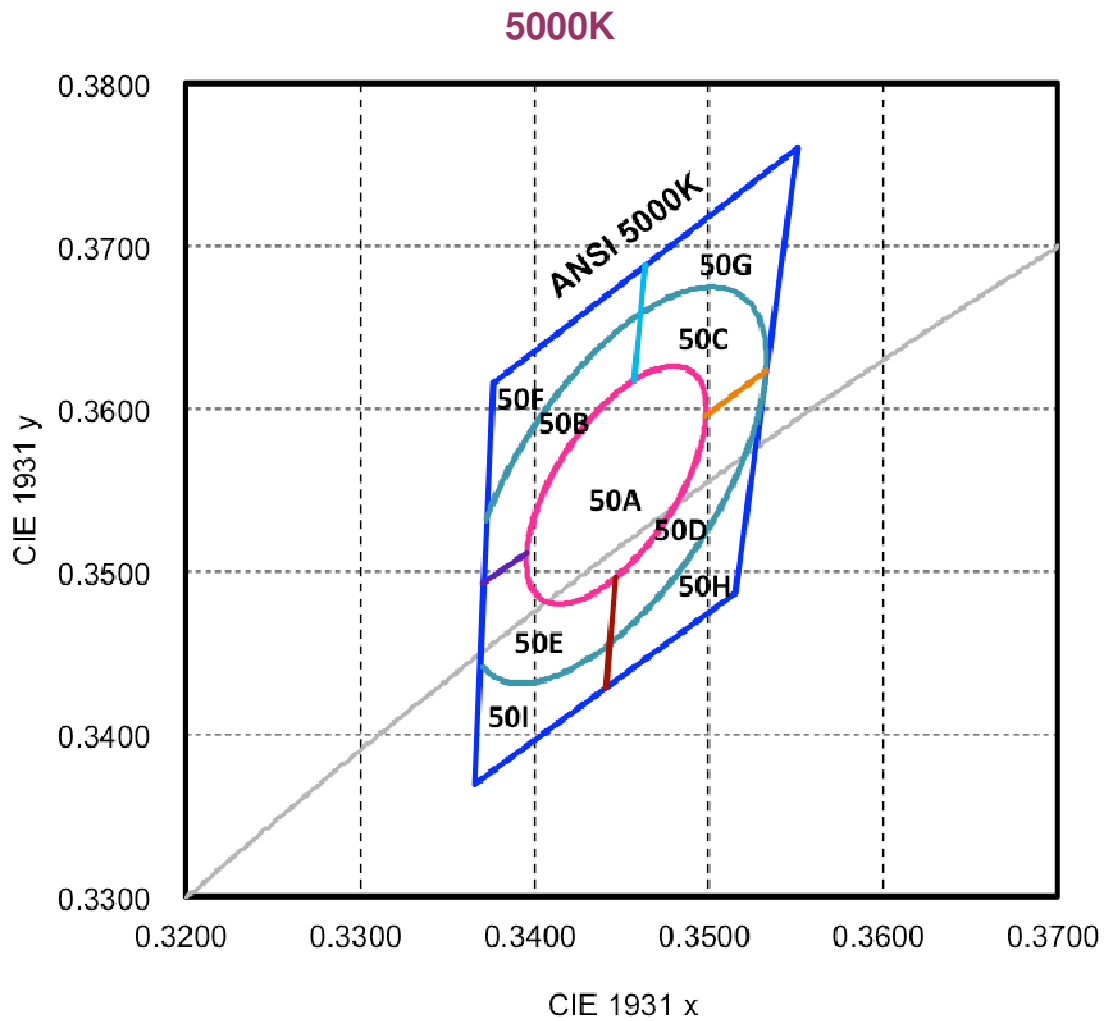

Nominal ANSI CCT	Color Space	Target Center Point (cx, cy)	Major Axis, a	Minor Axis, b	Ellipse Rotation Angle
5000K	Single 3-step MacAdam ellipse	(0.3447, 0.3553)	0.00822	0.00354	59.62°
5000K	Single 5-step MacAdam ellipse	(0.3447, 0.3553)	0.01370	0.00590	59.62°

5700K

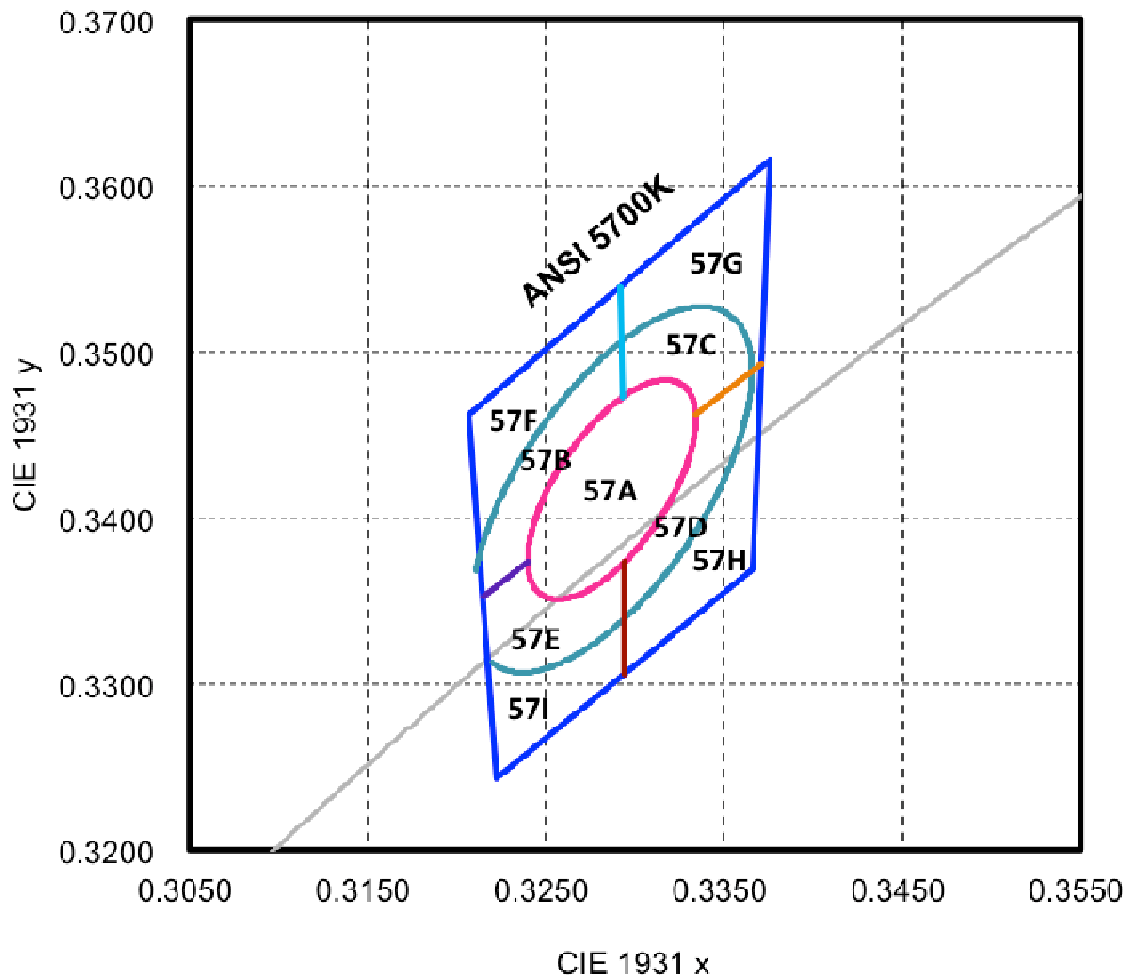

Nominal ANSI CCT	Color Space	Target Center Point (cx, cy)	Major Axis, a	Minor Axis, b	Ellipse Rotation Angle
5700K	Single 3-step MacAdam ellipse	(0.3287, 0.3417)	0.00746	0.00320	59.09°
5700K	Single 5-step MacAdam ellipse	(0.3287, 0.3417)	0.01243	0.00533	59.09°

6500K

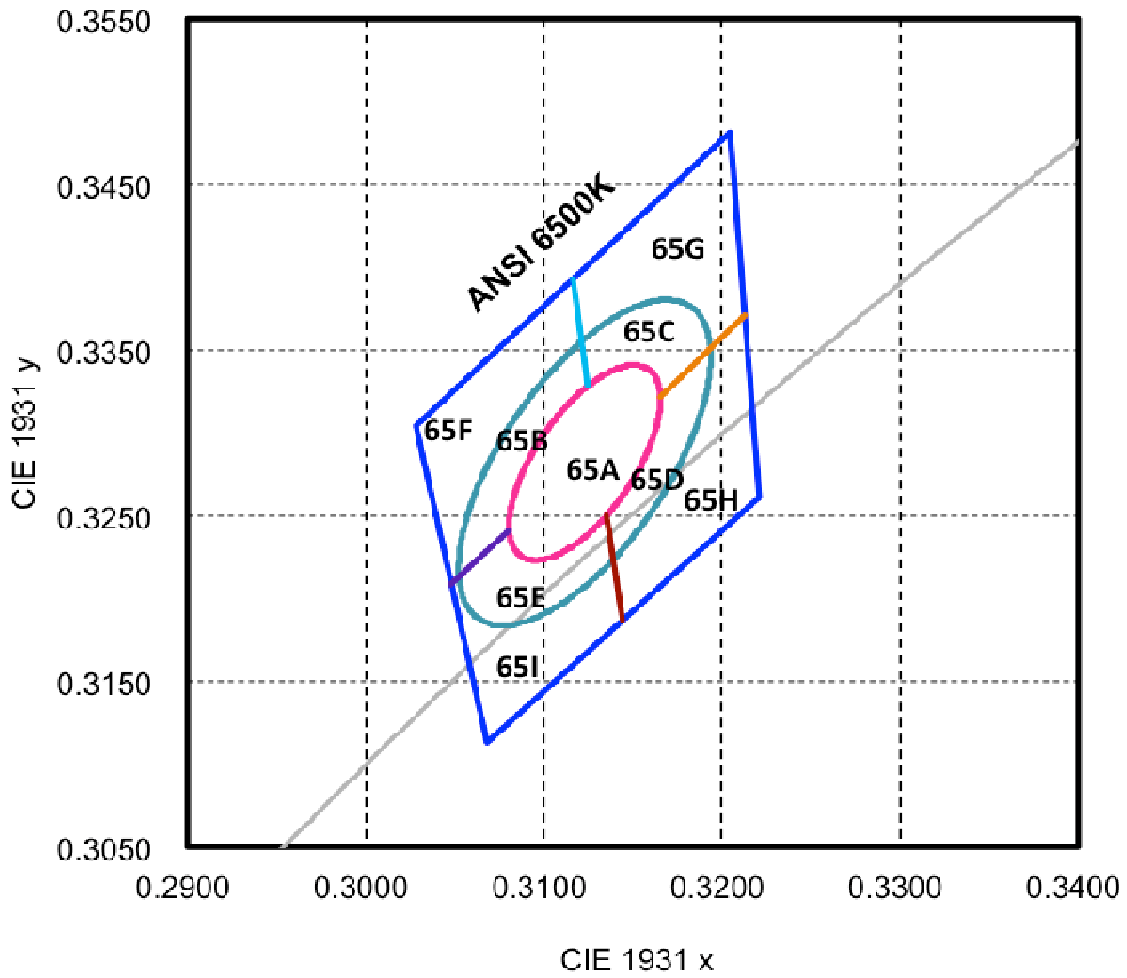

	Color Space	Target Center Point (cx, cy)	Major Axis, a	Minor Axis, b	Ellipse Rotation Angle
6500K	Single 3-step MacAdam ellipse	(0.3123, 0.3282)	0.00669	0.00285	58.57°
6500K	Single 5-step MacAdam ellipse	(0.3123, 0.3282)	0.01115	0.00475	58.57°

Note:

- (1) Correlated color Temperature is derived from the CIE 1931 Chromaticity diagram
- (2) Measurement tolerance is ± 0.005

Characteristics

PC30H08 V1

Product Specification

Spectrum

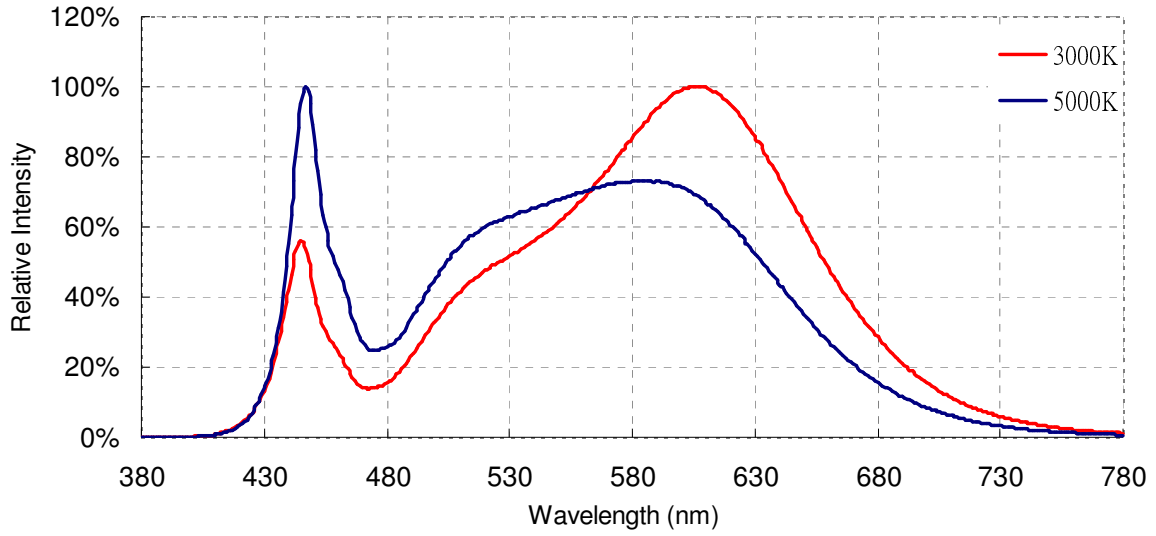

Radiation Pattern

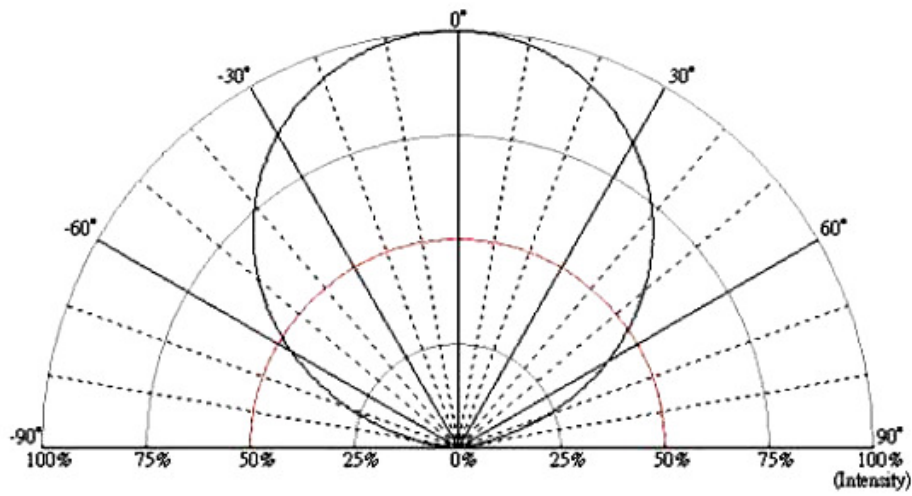

■ Forward Voltage vs. Forward Current

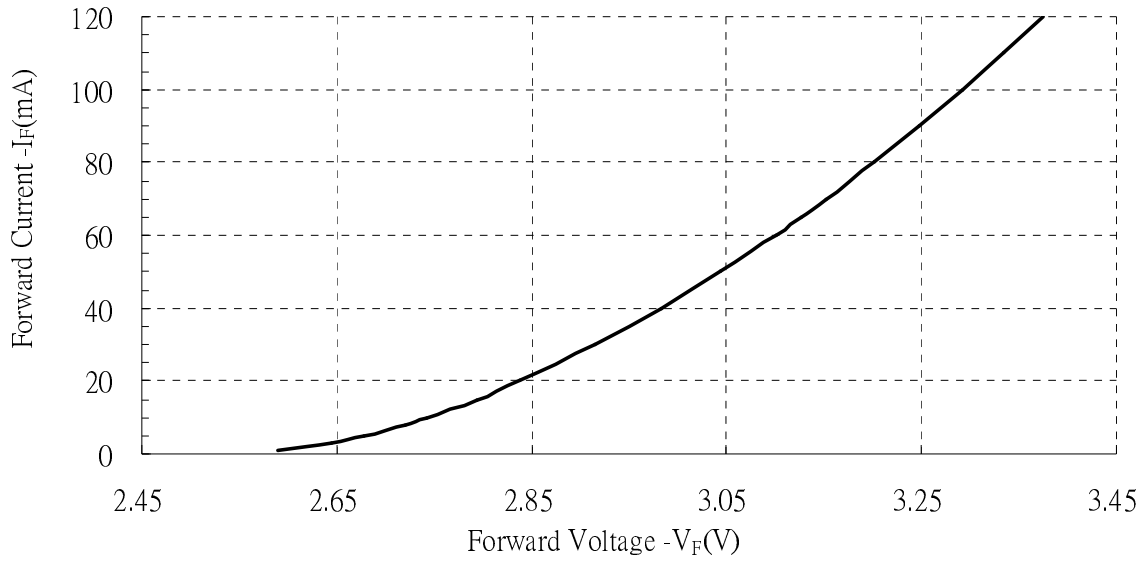

■ Forward Current vs. Relative Luminosity

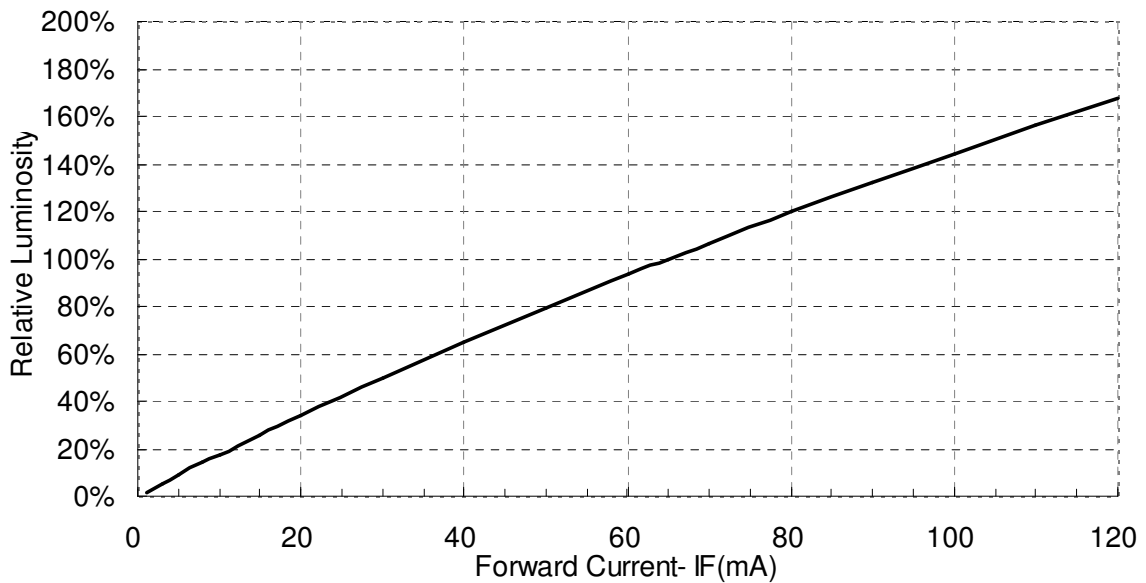

■ Forward Current vs. Chromaticity Coordinate

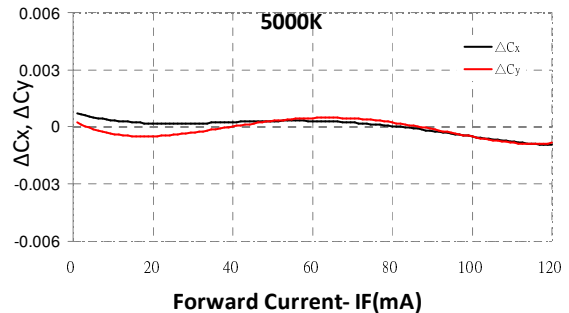
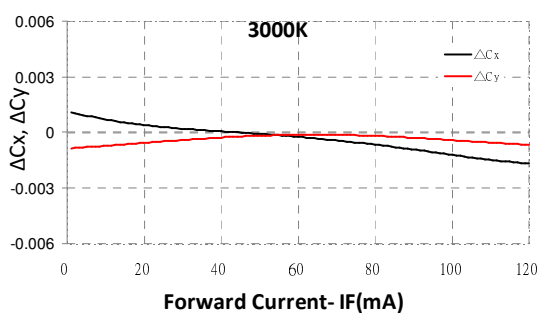

■ **Relative Forward Voltage vs. Ambient Temperature**

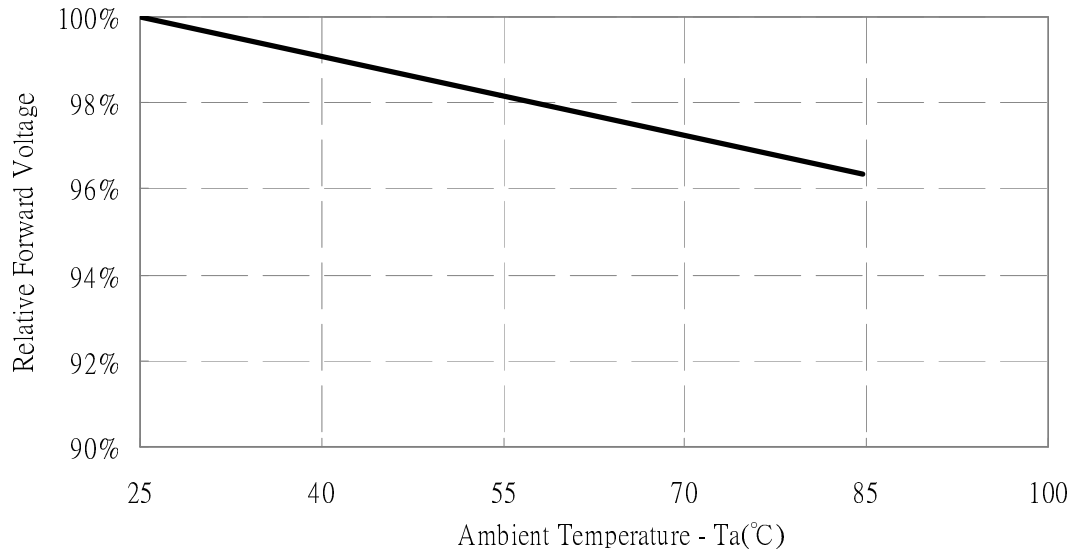

■ **Relative Luminous Intensity vs. Ambient Temperature**

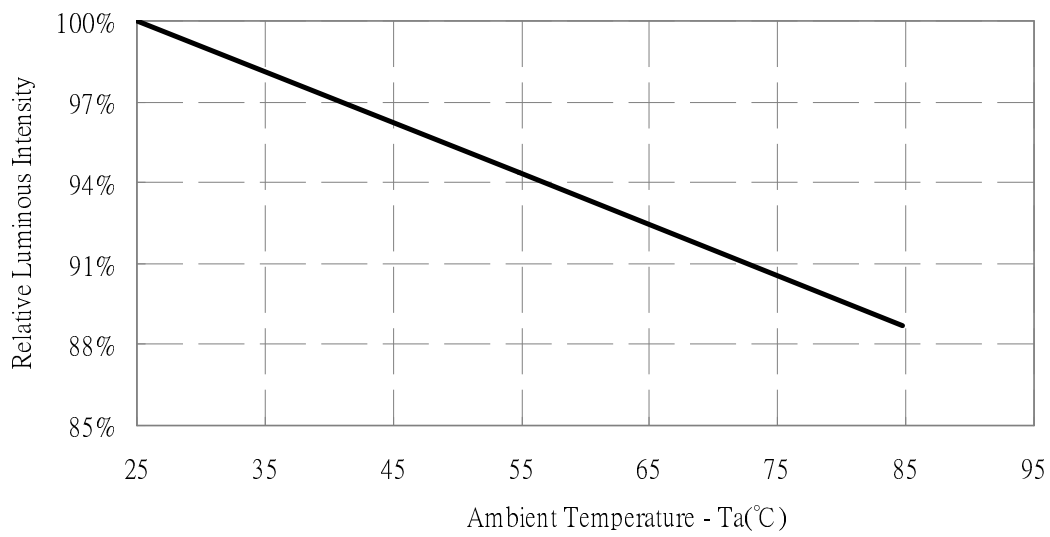

■ **Chromaticity vs. Ambient Temperature**

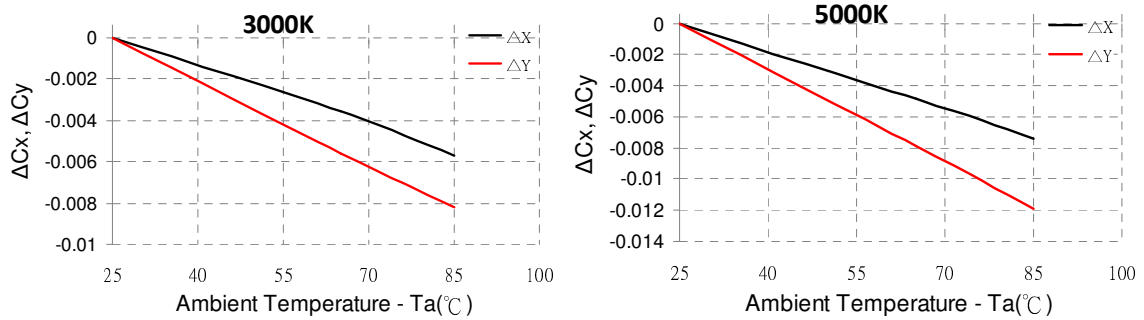

Reliability

PC30H08 V1
 Product Specification

■ Reliability test

Item	Condition	Time/Cycle
Steady State Operating Life of Low Temperature -40°C	-40°C Operating	1000 Hrs
Steady State Operating Life of High Temperature 60°C	60°C Operating	1000 Hrs
Steady State Operating Life of High Temperature 85°C	85°C Operating	1000 Hrs
Low temperature storage -40°C	-40°C Storage	1000 Hrs
High temperature storage 100°C	100°C Storage	1000 Hrs
Steady State Operating Life of High Humidity Heat 60°C 90%	60°C/90% Operating	1000 Hrs
Resistance to soldering heat on PCB (JEDEC MSL3)	pre-store@60°C, 60%RH for 52hrs Tslid max.=260°C 10sec	1 cycle 3 Times
Thermal shock	-40°C/20minr ~5minr ~ 100°C/20min	300 Cycles

■ Judgment Criteria

Item	Symbol	Test Condition	Judgment Criteria
Forward Voltage	Vf	65 mA	$\Delta V_f < 10 \%$
Luminous Flux	Iv	65 mA	$\Delta I_v < 30 \%$

Packing

PC30H08 V1
 Product Specification

■ Reel Label

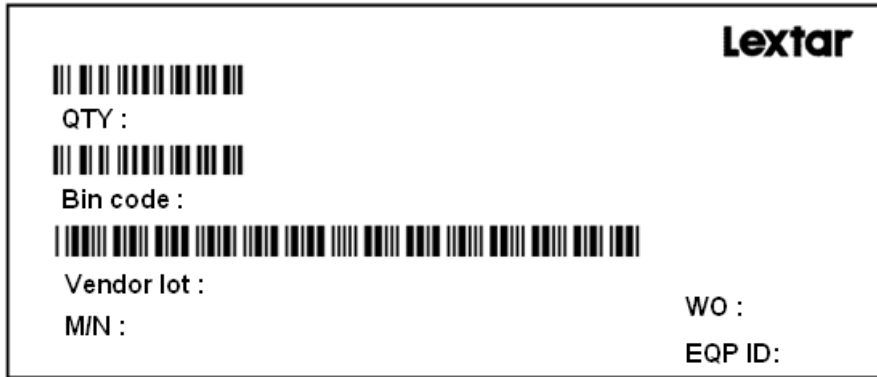

■ Carrier Tape Dimension

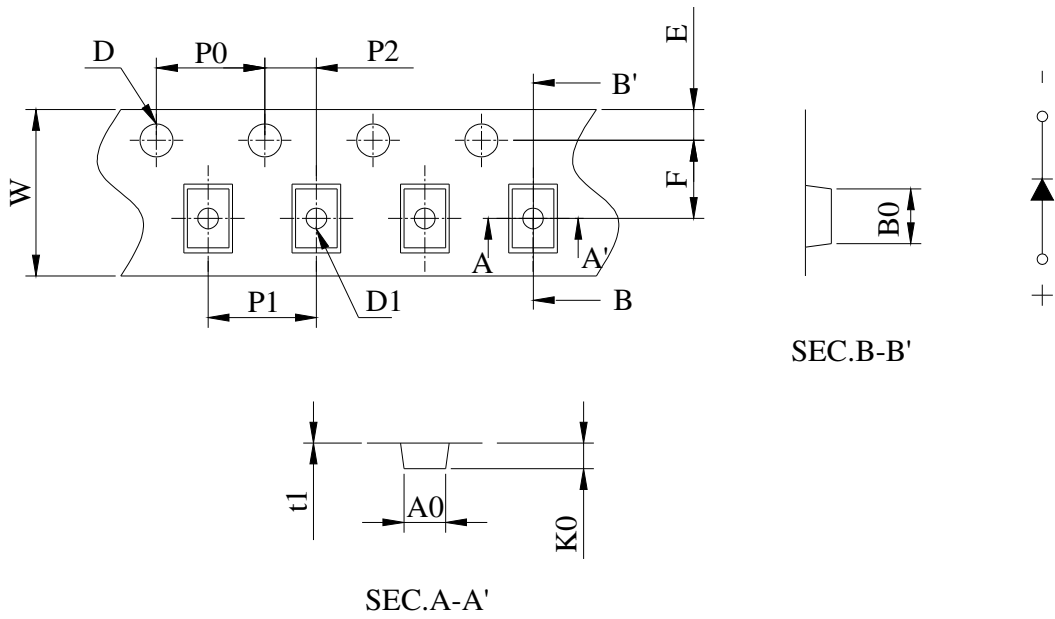

Item	Spec	Tol.(+/-)	Item	Spec	Tol.(+/-)
W	8.00	±0.1	P2	2.00	±0.05
E	1.75	±0.1	P0 x 10	40.00	±0.2
F	3.50	±0.05	t1	0.23	±0.05
D	1.50	+0.1,-0	A0	1.55	±0.1
D1	1.00	±0.1	B0	3.20	±0.1
P0、P1	4.00	±0.1	K0	0.95	±0.1

■ **Package**

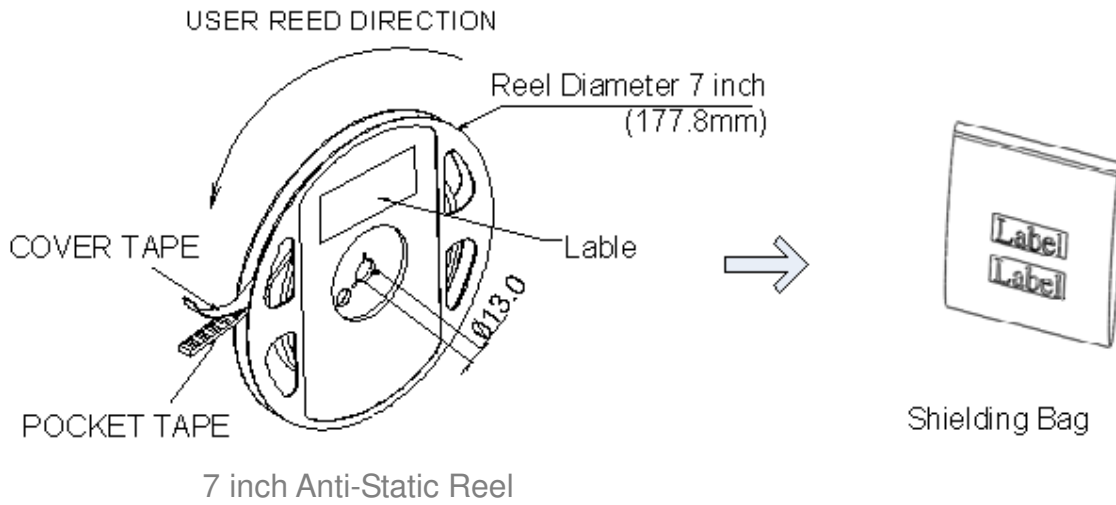

■ **Shield Bag Taping**

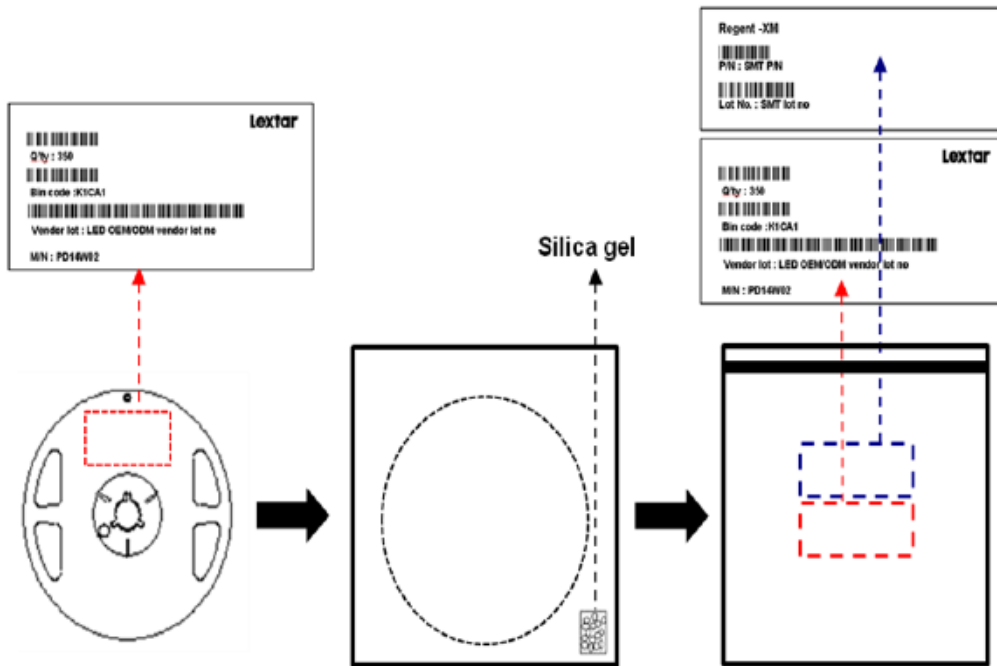

■ **Packing Box**

Type	Large Box	
Dimension	465X257X255mm	
Maximum Reels	7"X8mm Reel	40/R
Minimum Reels	7"X8mm Reel	20/R

Precautions

PC30H08 V1

Product Specification

■ Safety Precautions

- The LED light output is too strong for human eyes without shield. Prevent eye contact directly more than seconds.
- Ensure operating under maximum rating.

■ Storage

- Before opening the package, the LEDs should storage under 30°C, 70% RH.
- After opening the package bag, the LEDs should be keep under 30°C, 70% RH. Recommend to use within 168 hours. If unused LEDs remain, suggest to store into moisture proof bag or original package bag with moisture absorbent material such as silica gel. Reseal well is necessary.
- If the product exceeded the storage period or the moisture absorbent material faded away, baking treatment should be done by following conditions.
Bake condition: 60°C, 12hours (One time only).

■ Soldering Notice and Conditions

- When soldering LEDs,
- Do not solder/reflow the same LED over two times.
- Recommend soldering conditions:
Hand soldering: 350 °C max , 3 sec. max.
Reflow soldering: Pre-heat 180 °C max , 180 sec. max.
Peak 260°C max , 5 sec. max.

- Reflow temperature profile as below: (lead-free solder)

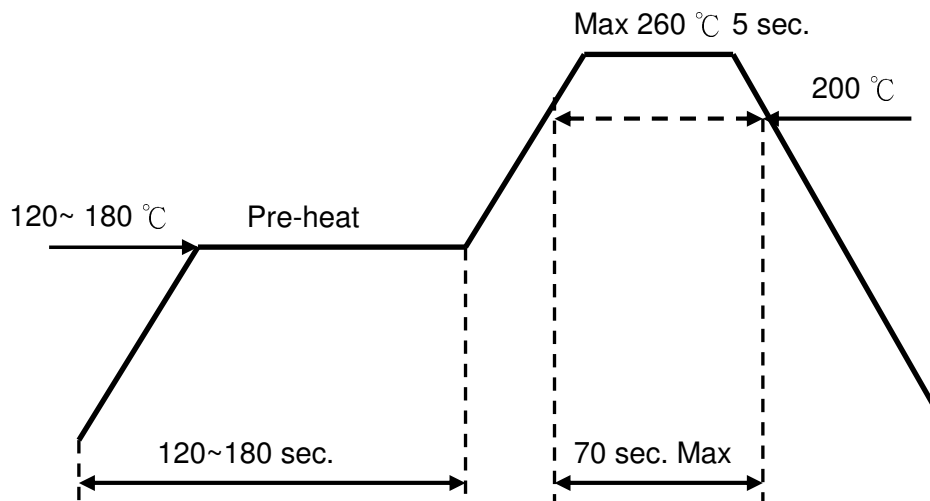

- When soldering, don't put stress on the LEDs
- After LEDs have been soldered, strongly recommend not to repair to keep the LEDs performance.

■ Static Electricity

- LED package is extremely sensitive to static electricity. It's recommended that anti-electrostatic glove and wrist band is necessary when handling the LEDs. All devices are also be grounded properly as well.
- Protection devices design should be considered in the LED driving circuit.

■ Cleaning

- If washing is required, recommend to use alcohol as a solvent.
- Recommend to avoid cleaning the LEDs by ultrasonic. If necessary, pre-test the LED is necessary to confirm whether any damage occur after the process.

Revision History

PC30H08 V1
Product Specification

Date	Contents	Writer	Approved
2016.01.19	New version	Ching Chen	Berris Huang
2016.06.20	Add ordering code	Ching Chen	Berris Huang

Smart Lighting *Amazing Life*

Lextar Electronics Corp. is the leading LED (Light Emitting Diode) maker integrating upper stream epitaxial, middle stream chip, and downstream package, SMT and LED lighting applications. Founded in May, 2008, Lextar is a subsidiary of AU Optronics, the leading TFT-LCD and solar PV manufacturer. Lextar's product applications include lighting and LCD backlight. Lextar's manufacturing sites include Hsinchu and Chunan in Taiwan, and Suzhou in China. The company turnover in 2010 is 266 million USD.